

# CRAFT DISTON

## Series 900-TR Hinged Shower Enclosure With Tile Rise

### SPECIFICATIONS:

General: All aluminum enclosures shall be series No. 900-TR as manufactured by Craft Fabricators, Ft. Scott, KS.

### MATERIALS AND CONSTRUCTION:

Aluminum extrusion to be 6063 T-5 alloy.  
Glass rail to be 1/4" in width.  
Fasteners to be rust resistant.  
Handles to be plated to matching color.

### FINISH:

Silver - Polished Bright Dip Anodized.  
Gold - Polished Bright Dip Gold Anodized.

To install your shower enclosure, you will need the following:

- level
- 3/32", 1/8" and 3/16" drill bits
- phillips screwdriver
- sealant

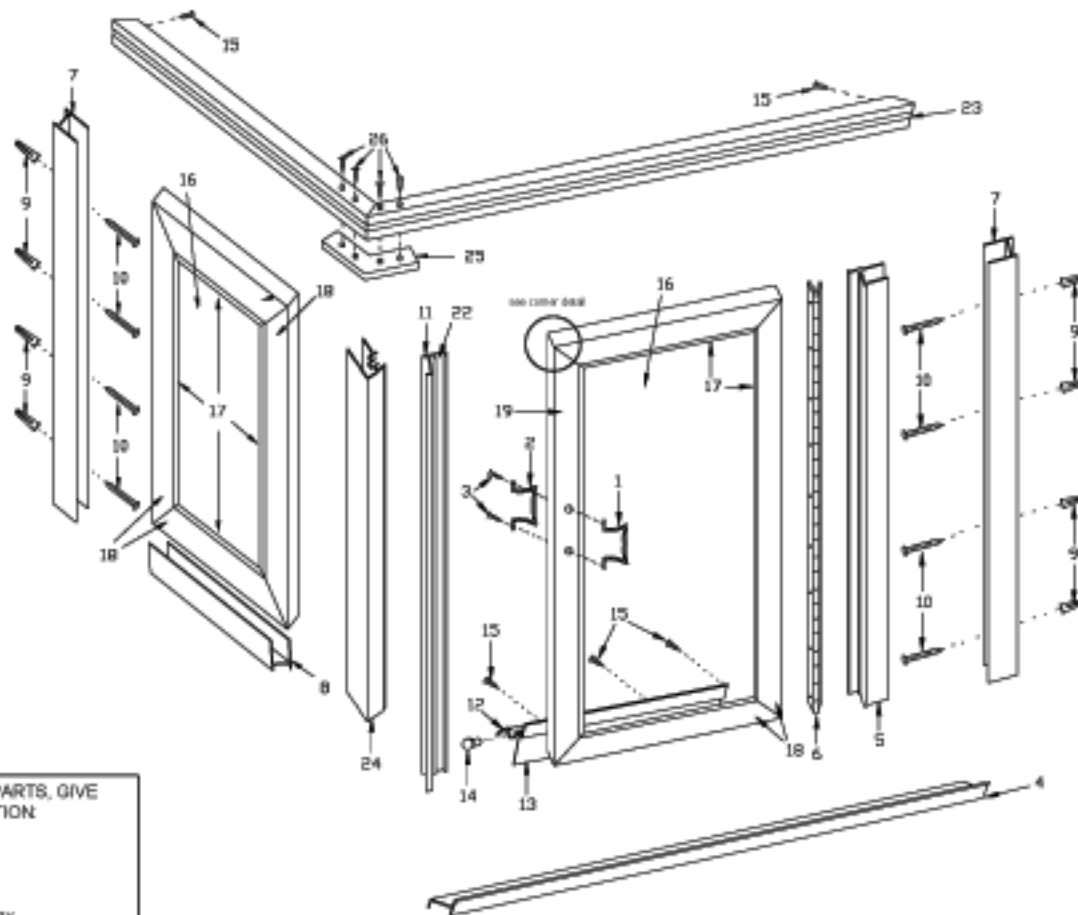

DESCRIPTION	QTY.	PART #	
1. Outside (male) door handle	1	VPC-125	
2. Inside (female) door handle	1	VPC-125	
3. #8-32 x 5/8" flat head machine screws	2		
4. Threshold	1	CFM-70	
5. Adjustable hinge jamb	1	CFM-4	
6. Hinge	1		
7. Wall channels	2	CFM-53	
8. Sill channel	1	CFM-53	
9. Wall anchors	8		
10. #6 x 1 1/2" truss head sheet metal screws	8		
11. Strike jamb	1	CFM-84	
12. Drip channel	1	CFM-40	
13. Drip channel vinyl	1	900	
14. Drip channel plug	1	62M9012	
15. #6 x 3/8" pan head sheet metal screws	23		
16. Tempered glass (glass units)	2	996	
17. Glazing vinyl	32 ft.	919	
18. Glass frames	7	CFM-1	
19. Magnetic glass frame	1	CFM-83	
20. Corner angles	8	193-1-1	
21. #8-32 x 1/2" flat head machine screws	16	301	
22. Magnetic strip	1		
23. Headers	2	CFM-34	
24. 90° corner post	1	CFM-57	
25. 90° header angle	1		
26. #6 x 1/2" pan head sheet metal screws	4		
27. #6 x 1" truss head sheet metal screws	2		

WHEN ORDERING REPAIR PARTS, GIVE THE FOLLOWING INFORMATION:

1. Part Number
2. Part Name
3. Model Number
4. Specify design, if any

## Step 1

Assemble door handles

SERIES 900-TR  
with tile rise

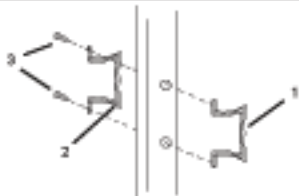

- attach outside (male) door handle (1) and inside (female) door handle (2) to door with two #6-32 x 5/8" flat head machine screws (3).
- set door assembly aside. (The inside door handle should be placed on the magnet side of the door.)

## Step 2

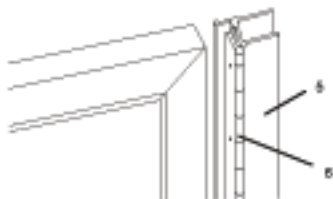

- this door is reversible and can swing to the right or left. (A right-swing door is shown.) Decide which way you wish your door to swing.

## Step 3

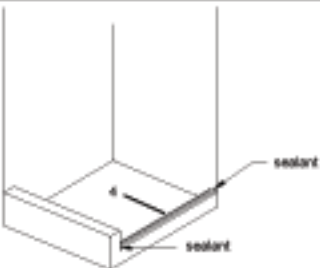

- measure curb from wall to tile rise for swing door opening.
- cut threshold (4) 1/16" less than opening width.
- Note:** Make sure high side of threshold is to the outside of shower.
- position threshold on curb and mark its position.

## Step 4

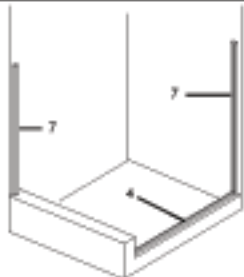

- position wall channels (7) on threshold (4).
- plumb wall channels and mark installation holes on wall.
- remove wall channels.
- for ceramic tile installation, use a 3/16" masonry bit for drilling installation holes and install plastic wall anchors (8).
- for fiber glass installation, use a 1/8" drill bit for drilling installation holes.

## Step 5

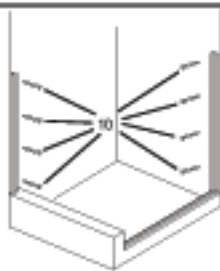

- remove threshold and build up sealant on each end of curb under threshold location.
- replace threshold to previous location.
- replace wall channels (7) in previous location.
- secure wall channels to wall with #6 x 1 1/2" truss head sheet metal screws (10).
- apply a liberal amount of sealant on inside of wall channels where wall channels meet thresholds.

## Step 6

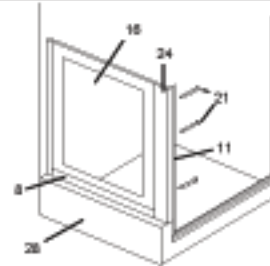

- cut sill channel (8) 1 1/4" less than panel width.
- attach sill channel to tile rise (28) with #6 x 1" truss head sheet metal screws (27).
- place stationary glass panel (16) into wall channel and sill channel. Do not secure.
- install 90° post (24) on glass panel.

## Step 7



- from long point of miter add 1/2" to centerline measurement (plus or minus wall variance) and cut headers (23) to size.
- Note:** Door and panel headers are sent from the factory in longer lengths than center line measurements.
- assemble headers using 90° angle (25) and #8 x 1/2" pan head sheet metal screws (26).
- place headers over wall channels and 90° post.
- secure header to wall channels and 90° post by drilling 3/32" holes and using #8 x 3/8" pan head screws.

## Step 8

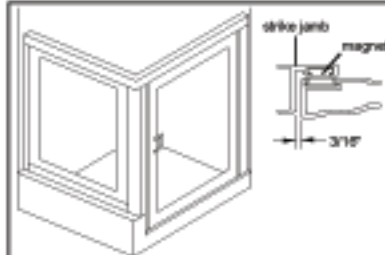

- place door hinge jamb (5 & 6) in wall channel (7).
- close door against strike jamb (11) making sure door is flush against strike jamb.
- adjust door to opening.
- secure hinge jamb to wall channel by drilling 3/32" holes and using #8 x 3/8" pan head sheet metal screws (15).
- secure glass panel to wall channel, sill channel and 90° post by drilling 3/32" holes and using #6 x 3/8" pan head sheet metal screws.
- NOTE:** If magnet does not pull door shut, reverse strike jamb magnet. Groove in magnets should match.

## Step 9

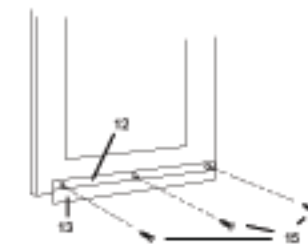

- cut drip channel (12) 1/4" less than panel width.
- notch drip channel 3/4" at hinge side to allow channel to overlap hinge jamb.
- using a file, round off both lower corners of drip channel.
- insert drip channel vinyl (13) into drip channel (12) and trim to size.
- insert plastic drip channel plug (14) into end of drip channel.
- with door closed, position drip channel on inside of door with a slope to the hinge side.
- mark the location, then clean door thoroughly with rubbing alcohol.
- peel protective cover off double face tape and install drip channel.
- for additional security, drill three 3/32" holes from drip channel into door.
- secure with three #6 x 3/8" pan head machine screws (15).
- IMPORTANT:** holes must be drilled a minimum of 3/8" below exposed glass.

## Step 10

- seal the inside and outside of the unit at any point unit meets wall or curb.
- Seal between outside of sill channel and high side of threshold.