

# CRAFT DISTON

## Series 401-AB Hinged Shower Enclosure

### SPECIFICATIONS:

General: All aluminum enclosures shall be series No. 401-AB as manufactured by Craft Fabricators, Ft. Scott, KS.

### MATERIALS AND CONSTRUCTION:

Aluminum extrusions to be of 6063 T-5 alloy. All screws to be stainless steel.

### FINISH:

Silver - Polished Bright Dip Anodized.  
Gold - Polished Bright Dip Gold Anodized.

To install your shower enclosure, you will need the following:

- level
- 3/32", 1/8" and 3/16" drill bits
- phillips screwdriver
- sealant

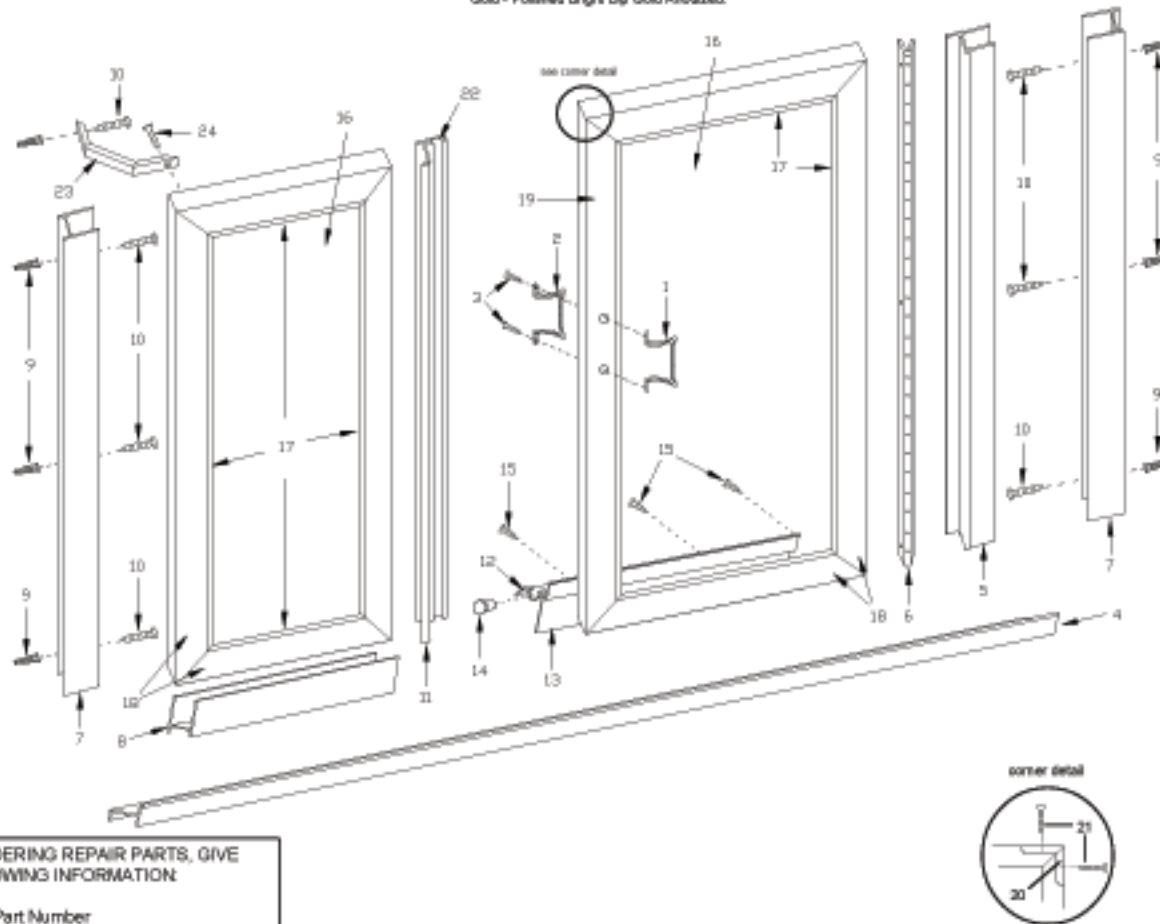

WHEN ORDERING REPAIR PARTS, GIVE THE FOLLOWING INFORMATION:

1. Part Number
2. Part Name
3. Model Number
4. Specify design, if any

DESCRIPTION	QTY.	PART #	
1. Outside (male) door handle	1	VPC-125	
2. Inside (female) door handle	1	VPC-125	
3. #6-32 x 5/8" flat head machine screws	2		
4. Threshold	1	CFM-70	
5. Adjustable hinge jamb	1	CFM-4	
6. Hinge	1		
7. Wall channels	3	CFM-53	
8. Sill channel	1	CFM-53	
9. Wall anchors	7		
10. #5 x 1 1/2" truss head sheet metal screws	7		
11. Strike jamb	1	CFM-84	
12. Dip channel	1	CFM-49	
13. Dip channel vinyl	1	900	
14. Dip channel plug	1	62M9012	
15. #6 x 3/8" pan head sheet metal screws	21		
16. Tempered glass (glass units)	2	998	
17. Glazing vinyl	32 ft.	919	
18. Glass frames	7	CFM-1	
19. Magnetic glass frame	1	CFM-83	
20. Corner angles	8	193-1-1	
21. #8-32 x 1/2" flat head machine screws	16	301	
22. Magnetic strip	1	M-225	
23. Angle brace	1	H-16	
24. #8 x 3/4" oval head sheet metal screw	1		

## Step 1

SERIES 401-AB

### Assemble door handles

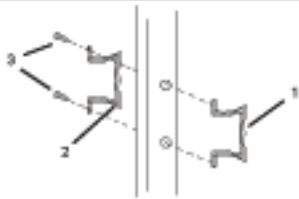

- attach outside (male) door handle (1) and inside (female) door handle (2) to door with two #6-32 x 5/8" flat head machine screws (3).
- set door assembly aside. (The inside door handle should be placed on the magnet side of the door.)

## Step 2

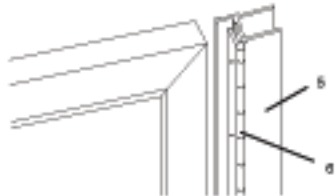

- this door is reversible and can swing to the right or left. (A right-swing door is shown.) Decide which way you wish your door to swing.
- after door swing has been determined, cut Hinge jamb (5) and wall channel (7) flush with top of door

## Step 3

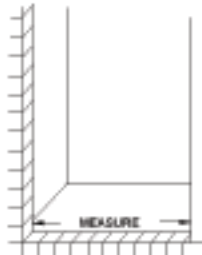

- measure the wall to wall opening of the shower curb.
- cut bottom threshold (4) 1/16" less than opening width.  
**Note:** Make sure high side of threshold is to the outside of shower.

## Step 4

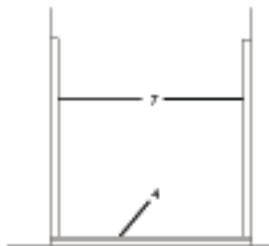

- position wall channels (7) on threshold (4), making sure threshold is centered on curb.
- plumb wall channels and mark installation holes on wall.
- remove all parts
- for ceramic tile installation, use a 3/16" masonry bit for drilling installation holes.
- install plastic wall anchors (8).
- for fiberglass installation, use a 1/8" drill bit for drilling installation holes.

## Step 5

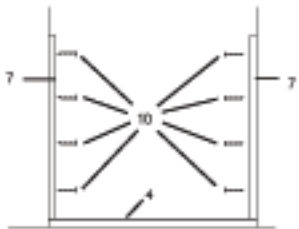

- place a bead of sealant on each end of curb under threshold location.
- replace threshold (4) on center of curb.
- replace wall channels (7) in previous location.
- secure wall channels to wall with three #6 x 1 1/2" truss head sheet metal screws (10).
- apply a liberal amount of sealant inside wall channels where wall channels meet threshold.

## Step 6

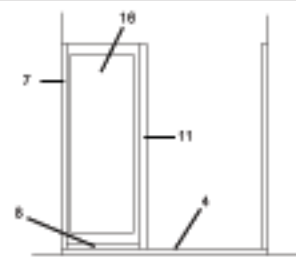

- cut sill channel (8) 3/4" less than panel width.
- secure sill channel to threshold by drilling 1/8" holes and using #8 x 1/2" pan head sheet metal screws.
- set glass panel (16) into wall channel (7) and sill channel. Do not secure.
- attach strike jamb (11) to stationary glass panel by drilling 1/8" holes and using three #6 x 1/2" flat head undercut screws to secure.

## Step 7

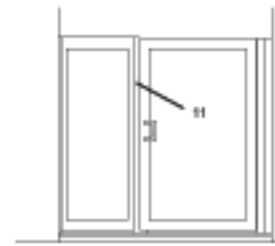

- position door on opposite wall.
- close door against strike jamb making sure door is flush against jamb.

## Step 8

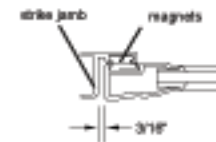

- adjust unit to opening.
- drill 3/32" holes in back of adjustable hinge jamb (5) and into wall channel (7).
- secure using three #6 x 3/8" pan head sheet metal screws.
- place angle brace (23) into position and secure to wall and panel.  
**NOTE:** If magnet does not pull door shut, reverse strike jamb magnet. Groove in magnets should match.

## Step 9

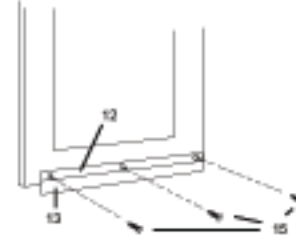

- cut drip channel (12) 1/4" less than panel width.
- notch drip channel 3/4" at hinge side to allow channel to overlap hinge jamb.
- using a file, round off both lower corners of drip channel.
- insert drip channel vinyl (13) into drip channel (12) and trim to size.
- insert plastic drip channel plug (14) into end of drip channel.
- with door closed, position drip channel on inside of door with a slope to the hinge side.
- mark the location, then clean door thoroughly with rubbing alcohol.
- peel protective cover off double face tape and install drip channel.
- for additional security, drill three 3/32" holes from drip channel into door.
- secure with three #6 x 3/8" pan head machine screws (15).  
**IMPORTANT:** holes must be drilled a minimum of 3/8" below exposed glass.

## Step 10

- seal the inside and outside of the unit at any point unit meets wall or curb. Seal between outside of sill channel and high side of threshold.