

CRAFT DISTON

Series 400 / 470 Hinged Shower Enclosure

SPECIFICATIONS:

General: All aluminum enclosures shall be series No. 400 as manufactured by Craft Fabricators, Ft. Scott, KS.

MATERIALS AND CONSTRUCTION:

Aluminum extrusions to be of 6063 T-5 alloy. All screws to be stainless steel.

FINISH:

Silver - Polished Bright Dip Anodized.
Gold - Polished Bright Dip Gold Anodized.

To install your shower enclosure, you will need the following:

- level
- 1/8", 1/4" and 9/64" drill bits
- phillips screwdriver
- sealant

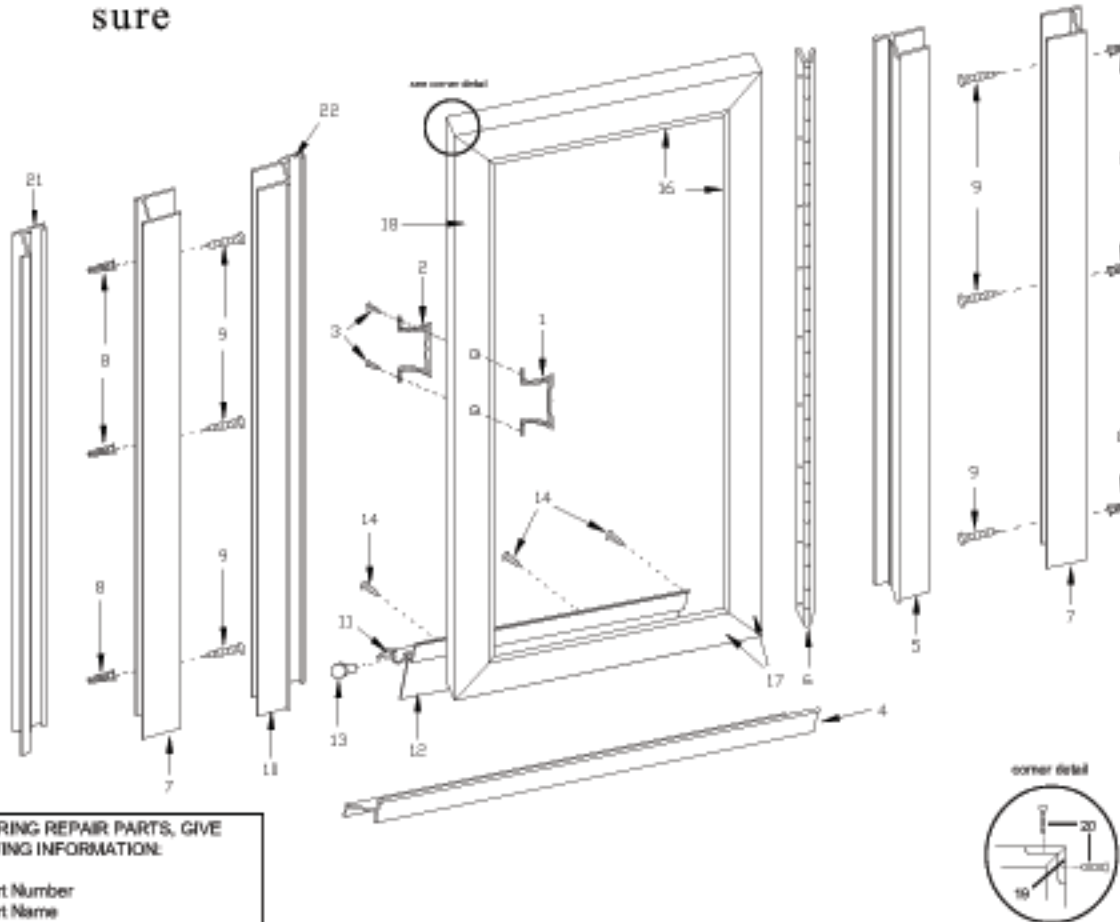

WHEN ORDERING REPAIR PARTS, GIVE THE FOLLOWING INFORMATION:

1. Part Number
2. Part Name
3. Model Number
4. Specify design, if any

DESCRIPTION	QTY.	PART #	
1. Outside (male) door handle	1	VPC-125	
2. Inside (female) door handle	1	VPC-125	
3. #8-32 x 5/8" flat head machine screws	2		
4. Threshold	1	CFM-70	
5. Expansion hinge jamb	1	CFM-4	
6. Hinge	1		
7. Wall channels	2	CFM-53	
8. Wall anchors	6		
9. #8 x 1 1/2" truss head sheet metal screws	6		
10. Expansion strike jamb	1	CFM-54	
11. Drip channel	1	CFM-49	
12. Drip channel vinyl	1	900	
13. Drip channel plug	1	62M8012	
14. #6 x 3/8" pan head sheet metal screws	9		
15. Tempered glass (glass units)	1	998	
16. Glazing vinyl	16 ft.	919	
17. Glass frame	3	CFM-1	
18. Magnetic glass frame	1	CFM-83	
19. Corner angles	4	183-1-1	
20. #8-32 x 1/2" flat head machine screws	8	301	
21. Standard strike jamb (for door with one adjustable jamb)	1	CFM-84	
22. Magnetic strip	2	M-225	

Step 1

SERIES 400 / 470

Assemble door handles

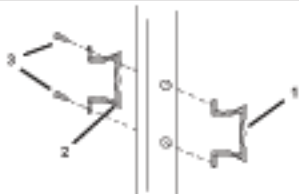

- attach outside (male) door handle (1) and inside (female) door handle (2) to door with two #6-32 x 5/8" flat head machine screws (3).
- set door assembly aside. (The inside door handle should be placed on the magnet side of the door.)

Step 2

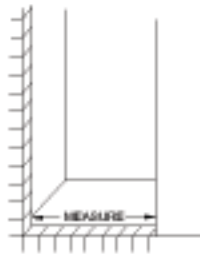

- this door is reversible and can swing to the right or left. (A right-swing door is shown.) Decide which way you wish your door to swing.
- measure the wall to wall opening of the shower curb.
- cut bottom threshold (4) 1/16" less than opening width.
Note: Make sure high side of threshold is to the outside of shower.

Step 3

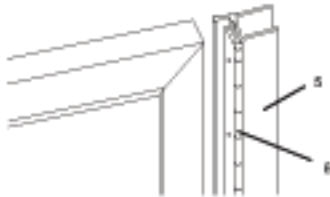

- after door swing has been determined, cut adjustable hinge jamb (5) and wall channel (7) flush with top of door

Step 4

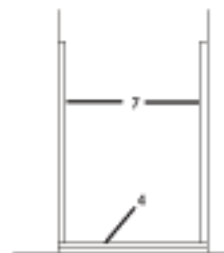

- position wall channels (7) on threshold (4), making sure threshold is centered on curb.
- plumb wall channels (7) and mark installation holes on wall.
- remove all parts
- for ceramic tile installation, use a 3/16" masonry bit for drilling installation holes.
- install plastic wall anchors (8).
- for fiberglass installation, use a 1/8" drill bit for drilling installation holes.

Step 5

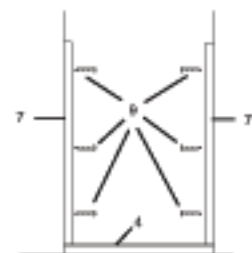

- replace wall channels (7) in previous location.
- secure wall channels to wall with six #8 x 1 1/2" truss head sheet metal screws (9).

Step 6

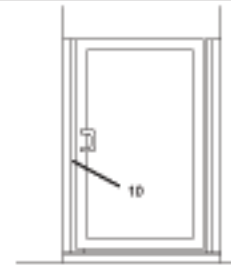

- place adjustable strike jamb (10) into wall channel (if this option is ordered) or standard jamb (21) against wall.
- close door against strike jamb making sure door is flush against jamb.

Step 7

Units with standard jambs

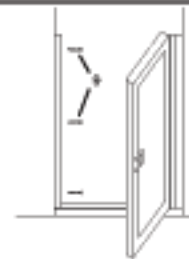

- plumb standard strike jamb (21).
- mark holes on wall (units with standard jamb).
- remove strike jamb.
- using a 3/16" masonry bit, drill installation holes and install plastic wall anchors (8).
- replace strike jamb (21), secure to wall with three #6 x 1 1/2" truss head sheet metal screws (9).

Step 8

Units with adjustable jambs

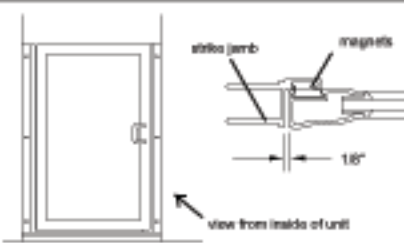

- adjust unit to opening.
- drill 3/32" holes in back of adjustable strike jamb (10) and hinge jamb (5).
- secure using six #6 x 3/8" pan head sheet metal screws (14).
- NOTE:** If magnet does not pull door shut, reverse strike jamb magnet. Groove in magnets should match.

Step 9

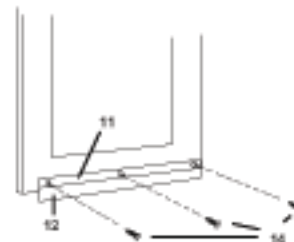

- cut drip channel (12) 1/4" less than panel width.
- notch drip channel 3/4" at hinge side to allow channel to overlap hinge jamb.
- using a file, round off both lower corners of drip channel.
- insert drip channel vinyl (13) into drip channel (12) and trim to size.
- insert plastic drip channel plug (14) into end of drip channel.
- with door closed, position drip channel on inside of door with a slope to the hinge side.
- mark the location, then clean door thoroughly with rubbing alcohol.
- peel protective cover off double face tape and install drip channel.
- for additional security, drill three 3/32" holes from drip channel into door.
- secure with three #6 x 3/8" pan head machine screws (15).
- IMPORTANT:** holes must be drilled a minimum of 3/8" below exposed glass.

Step 10

- seal with silicone the inside and outside of the unit at any point unit meets wall or curb.