

CRAFT DISTON

Series 1400 / 1401 Tub Enclosure

SPECIFICATIONS:

General: All aluminum enclosures shall be series No. 1400 / 1401 as manufactured by Craft Fabricators, Ft. Scott, KS.

MATERIALS AND CONSTRUCTION:

Aluminum extrusions to be of 6063 T-5 alloy.
All glass frames to be 1" in width.
All fasteners shall be stainless steel.
All guides and glazing materials to be vinyl.
Bearings to be ball bearing with nylon races.
Handle and towel bar brackets to be chrome or gold plated.

FINISH:

Silver - Bright Dip Anodized.
Gold - Bright Dip Gold Anodized.

To install your shower enclosure, you will need the following:

- level
- 1/8" and 3/16" drill bits
- phillips screwdriver
- sealant

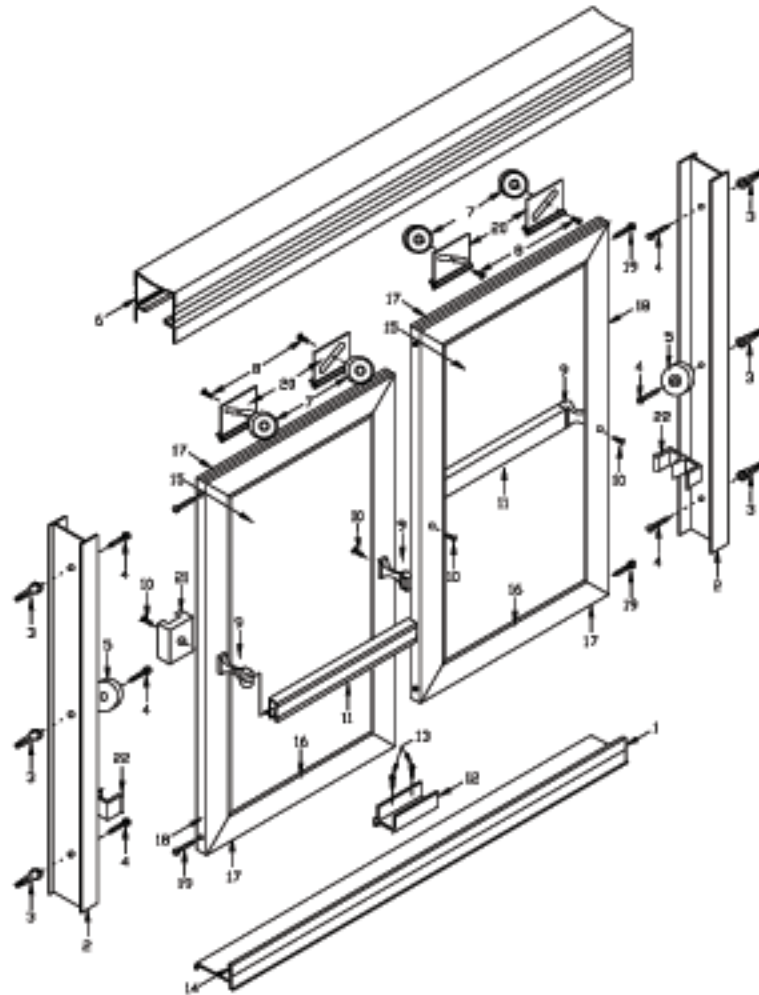

WHEN ORDERING REPAIR PARTS, GIVE THE FOLLOWING INFORMATION:

1. Part Number
2. Part Name
3. Model Number
4. Specify design, if any

DESCRIPTION	QTY.	PART #	
1. Track	1	CFM-32	
2. Wall jamba	2	CFM-27	
3. Wall anchors	8		
4. #8 x 1 1/2" truss head sheet metal screws	6		
5. Bumpers	2	9003157802	
6. Header	1	CFM-17	
7. Rollers	4	1193	
8. 8-32 x 3/8" pan head machine screw (SEMS)	4		
9. Towel bar brackets	4	1919	
10. 6-32 x 1/2" truss head machine screw	4		
11. Towel bars	2	CFM-11	
12. Vinyl guide	1	828	
13. #6 x 3/8" flat head sheet metal screws	2		
14. Track silencer	1	622	
15. Tempered glass (glass units)	2	998	
16. Glazing vinyl	34 ft.	919	
17. Horizontal door frames	4	CFM-28	
18. Vertical door frames	4	CFM-26	
19. #7 x 7/8" oval head sheet metal screw	8		
20. Roller brackets	4	43	
21. By-pass door stop	1	930	
22. Wall jamb guide	2	2404	

Step 1

SERIES 1400 / 1401

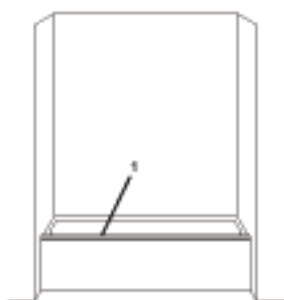

- measure the wall to wall opening on tub rim.
- cut track (1) 3/16" less than opening width.
- center vinyl guide (12) on track.
- using a 3/32" drill bit, drill holes and secure vinyl guide to track with two #6 x 3/8" flat head machine screws (13).

Step 2

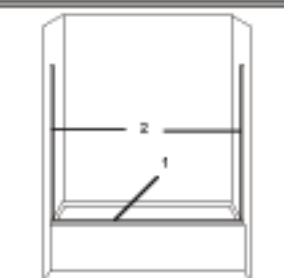

- place track (1) on center of tub rim.
- set jamba (2) firmly in track (1) next to wall.
- plumb and mark installation holes on wall.
- Note:** it is important that the wall jamba are plumb.
- if track does not fit flat, a slight bending of the track might be needed.

Step 3

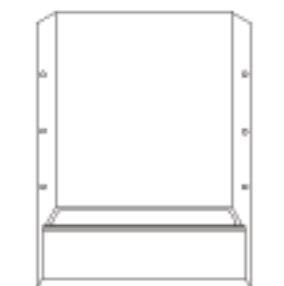

- remove all parts.
- for ceramic tile installation, use a 3/16" masonry bit for drilling installation holes and install plastic wall anchors (3).
- for fiberglass walls, use a 1/8" drill bit for drilling installation holes.

Step 4

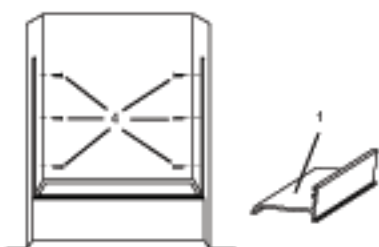

- apply a continuous bead of sealant to the bottom legs of track. A build up of sealant on each end of the tub rim (where track is to fit) will be needed.
- replace track in previous location.
- replace jamba (2) and secure to wall with six #8 x 1 1/2" truss head sheet metal screws (4).
- Note:** install bumpers with center installation screw.
- place wall jamb guides near the bottom of each wall channel.

Step 5

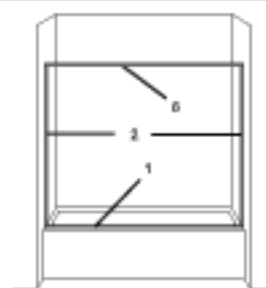

- measure the wall to wall opening above the wall jamba.
- cut header (6) 1/16" less than opening
- place header over jamba

Step 6

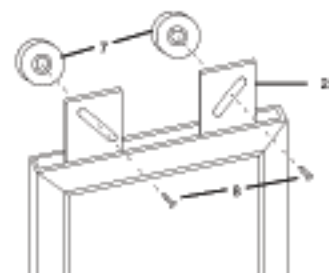

- attach rollers (7) to brackets (20) on top of doors with four #8-32 x 3/8" pan head machine screws (SEMS) (8) as shown.

Step 7



- lift inside door into header, placing rollers down in track.
- fit panel to wall by adjusting rollers.
- Note:** inside panel must be adjusted to the wall with the shower head.
- use the same procedure for outside door.

Step 8

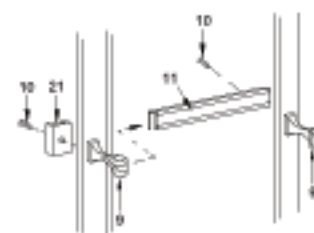

- insert towel bar brackets (8) into towel bar ends (11).
- insert #8-32 x 1/2" truss head machine screw (10) through door and into towel bar (11).
- install the by-pass door stop (21) on the inside of the outside panel farthest from the shower head. It can also be installed on the outside of the inside panel next to the shower head.
- towel bar is to be attached to the outside of the outside door and to the inside of the inside door to allow the doors to pass each other freely.

Step 9

- seal inside and outside of unit at any point unit meets wall or curb.