

CRAFT DISTON

Biscayne Series Hinged Shower Enclosure

INSTALLATION INSTRUCTIONS

Model Numbers

SHOWER ENCLOSURE
791M

Hinge door with (1) in-line panel
and (2) 135° panels

To install your shower enclosure, you will need the following:

- level
- 3/32", 1/8" and 3/16" drill bits
- phillips screwdriver
- sealant

GLAZED
includes glass

KD
does not
include glass

NOTE: K.D. units include all metal parts and hardware, but do not include glass. Glass size equals frame size less 1 1/2" in height and width.

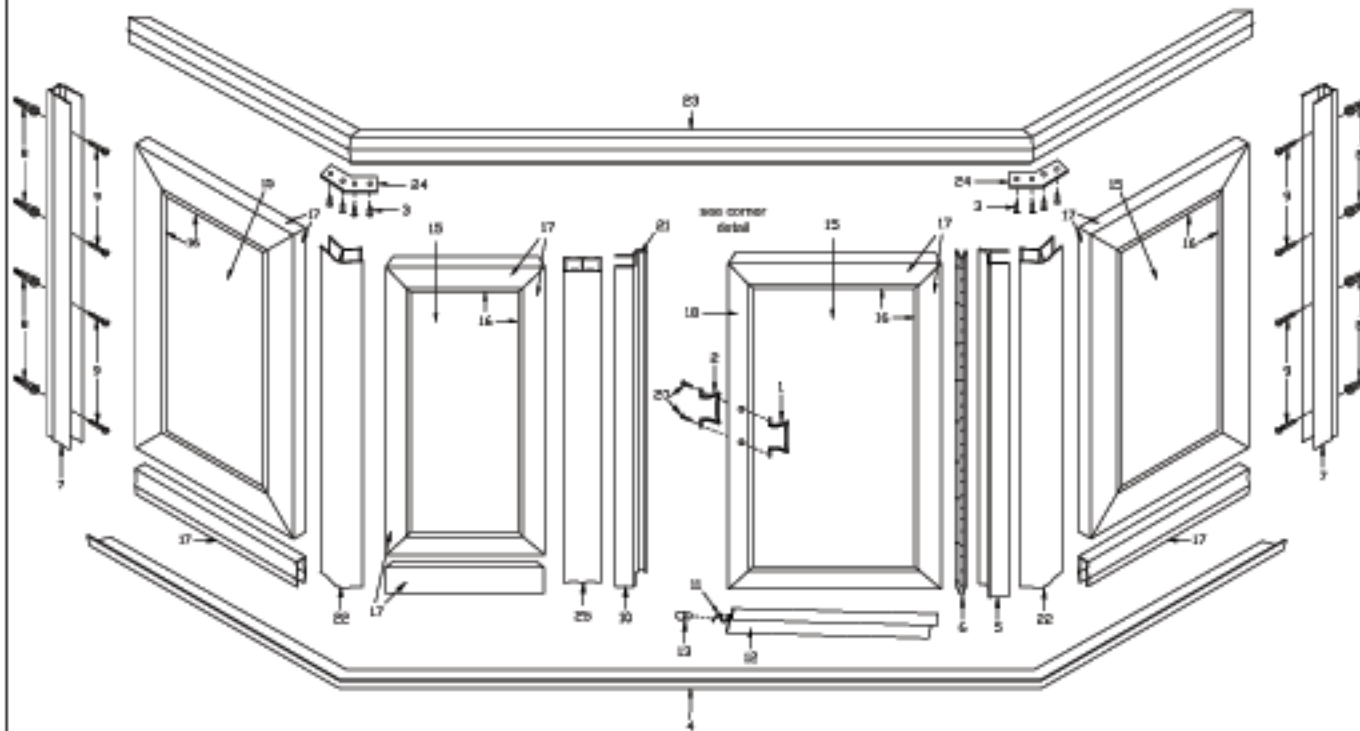

Corner Detail



When Ordering Repair Parts, Please Give The Following Information:

1. Part Number
2. Part Name
3. Model Number
4. Specify design, if any

Description	Qty.	Part #	
1. Outside (male) door handle	1	8153	
2. Inside (female) door handle	1	8149	
3. #8 x 1/2" PH SMS	8	306	
4. Thresholds	3	SSI-113	
5. Hinge jamb	1	SSI-88	
6. Hinge	1	675	
7. Wall channels	2	SSI-97	
8. Wall anchors	8	NC240	
9. #8 x 1" PH SMS	8	300	
10. Strike jamb	1	SSI-141	
11. Drip channel	1	CFM-49	
12. Drip channel vinyl	1	V1596	
13. Drip channel plug	1	NC312	
14. #6 x 3/8" PH SMS	42	205	
15. Tempered glass (glass units)	4		
16. Glazing vinyl	87 ft.		
17. Glass frames	18	SSI-78	
18. Magnetic door frame	1	SSI-140	
19. Corner brackets	16	SS252	
20. #8-32 x 1/2" FH MS	32	301	
21. Magnetic strip	1	M-1354	
22. 135° corner posts	2	SSI-87	
23. Headers	3	SSI-44	
24. 135° header bracket	2	PP251	
25. H mullion	1	SSI-85	

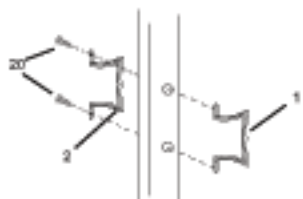

Step 1

MODEL 791M

Assemble door handles

- attach outside (male) door handle (1) and inside (female) door handle (2) to door with two #8-32 x 1/2" flat head machine screws (20).
- set door assembly aside. (The inside door handle should be placed on the magnet side of the door.)

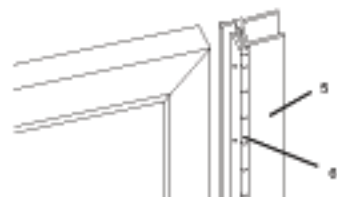

Step 2

- this door is reversible and can swing to the right or left. (A right-swing door is shown.) Decide which way you wish your door to swing.

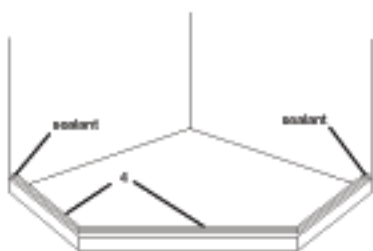

Step 3

- from long point of miter add 1/4" to centerline measurement and cut right and left thresholds (4) to size.
- Note:** The center threshold is cut to size on glazed units.
- position thresholds on curb and mark position.

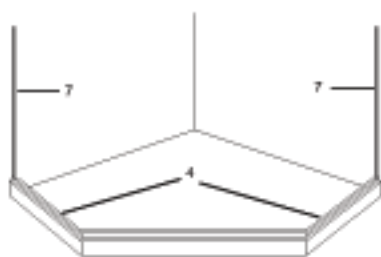

Step 4

- position wall channels (7) on threshold (4).
- plumb wall channels and mark installation holes on wall.
- remove wall channels.
- for ceramic tile installation, use a 3/16" masonry bit for drilling installation holes and install plastic wall anchors (8).
- for fiber glass installation, use a 1/8" drill bit for drilling installation holes.

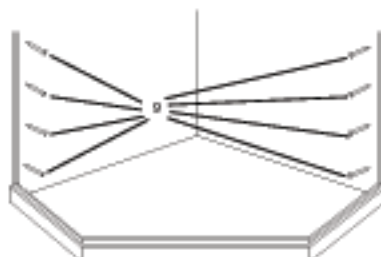

Step 5

- remove thresholds and build up sealant on each end of curb under threshold location.
- replace thresholds to previous location.
- replace wall channels (7) in previous location.
- secure wall channels to wall with #8 x 1" truss head sheet metal screws (8).
- apply a liberal amount of sealant on inside of wall channels where wall channels meet thresholds.

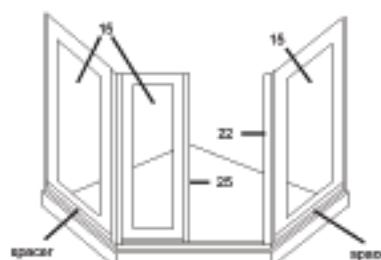

Step 6

- place stationary glass panels (15) into wall channels. Do not secure.
- install 135° posts (22) on glass panels.
- place strike jamb into 135° post.
- place H mullion (25) on to in-line glass panel.

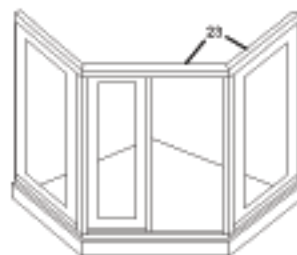

Step 7

- from long point of miter add 1/2" to centerline measurement (plus or minus wall variance) and cut right and left headers (23) to size.
- Note:** The center header is cut to size on glazed units.
- assemble headers using 135° brackets (24) and #8 x 1/2" pan head sheet metal screws (3).
- place headers over wall channels and 135° posts.

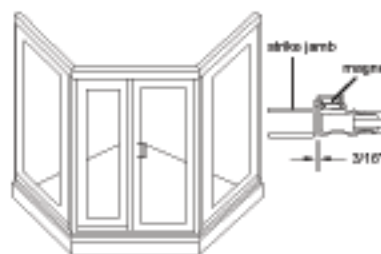

Step 8

- place door hinge jamb into corner post (22).
- close door against strike jamb making sure door is flush against strike jamb (10).
- adjust door to opening.
- secure hinge jamb (5 & 6) to corner post and strike jamb to H mullion by drilling 3/32" holes and using #6 x 3/8" pan head sheet metal screws (14).
- secure glass panels to wall channels, and 135° posts by drilling 3/32" holes and using #6 x 3/8" pan head sheet metal screws.
- secure header to wall channels and 135° posts by drilling 3/32" holes and using #6 x 3/8" pan head screws (14).
- NOTE:** If magnet does not pull door shut, reverse strike jamb magnet. Grooves in magnets should NOT match.

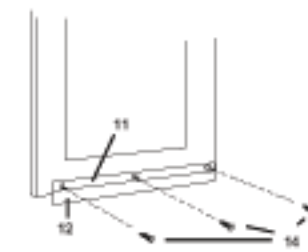

Step 9

- cut drip channel (11) 1/4" less than panel width.
- notch drip channel 3/4" at hinge side to allow channel to overlap hinge jamb.
- using a file, round off both lower corners of drip channel.
- insert drip channel vinyl (12) into drip channel (11) and trim to size.
- insert plastic drip channel plug (13) into end of drip channel.
- with door closed, position drip channel on inside of door with a slope to the hinge side.
- mark the location.
- drill three 3/32" holes from drip channel into door.
- secure with three #8 x 3/8" pan head machine screws (14).
- IMPORTANT:** holes must be drilled a minimum of 3/8" below exposed glass.

Step 10

- seal the inside and outside of the unit at any point unit meets wall or curb. Seal between outside of bottom spacer and high side of threshold.