

# CRAFT DISTON

## Biscayne Series Tub/Shower Enclosure

### INSTALLATION INSTRUCTIONS

#### Model Numbers

Tub Enclosure 690B	Shower Enclosure 772B
-----------------------	--------------------------

(2) by-passing doors with (2) 135° panels

To install your shower enclosure, you will need the following:

- level
- 3/32", 1/8" and 3/16" drill bits
- phillips screwdriver
- sealant

GLAZED  
includes glass

KD  
does not  
include glass

**NOTE:** K.D. units include all metal parts and hardware, but do not include glass. Glass size equals frame size less 1 1/2" in height and width.

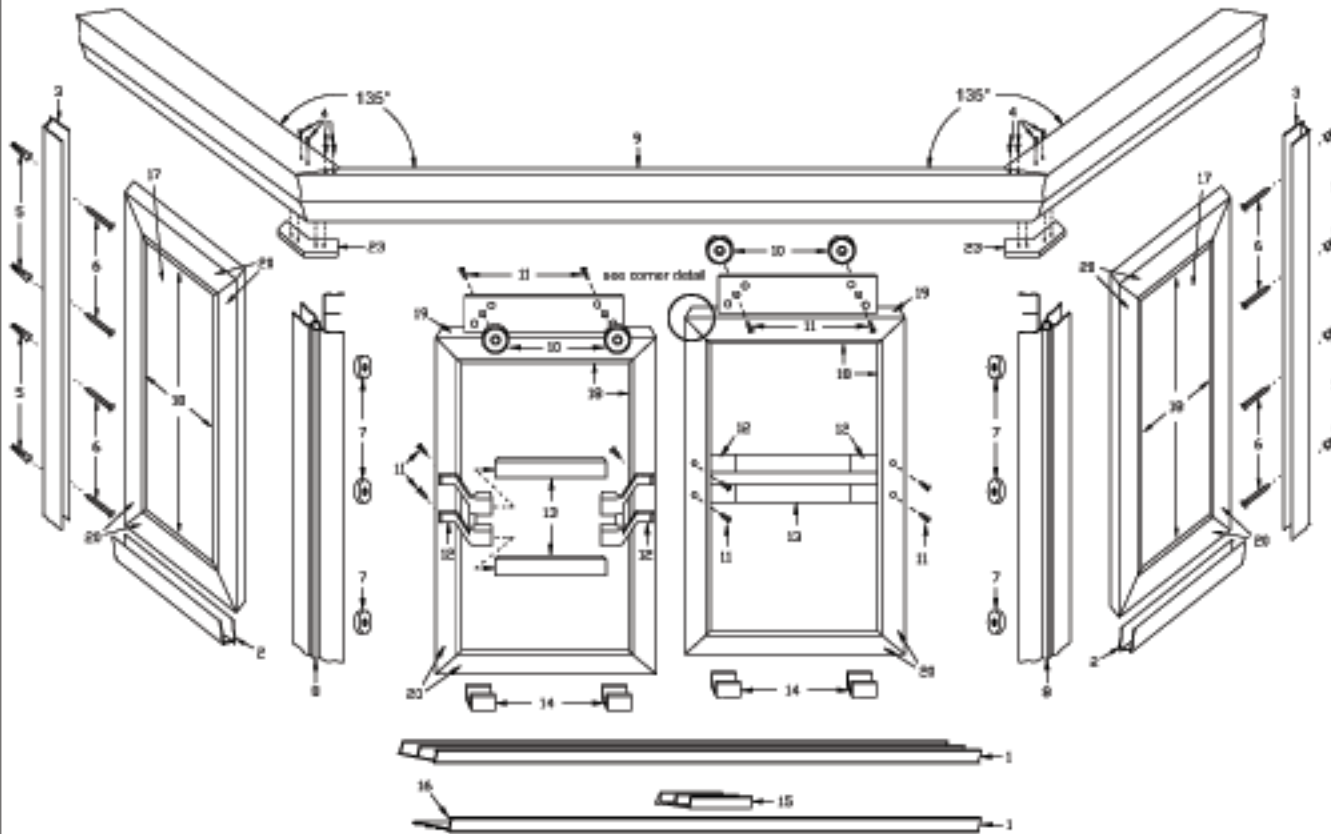

Corner Detail



Description	Qty.	Part #	
1. Track (part # SSI-122 used in Clean Track models)	1 or 1	SSI-64 SSI-122	
2. Sill channels	2	SSI-97	
3. Panel wall channels	2	SSI-97	
4. #8 x 3/8" PH SMS	30	205	
5. Wall anchors	8	NC240	
6. #8 x 1" TH SMS	8	300	
7. Bumpers	6	NC220	
8. Corner post assemblies	2	SSI-90M97F	
9. Headers	3	SSI-226	
10. Rollers	4	NC260	
11. 8-32 x 3/8" TH MS	12	302	
12. Towel bar brackets (double)	4	212	
13. Towel bars	4	SSI-40	
14. Nylon door guides (used in Standard Track models)	4	NC230	
15. Vinyl door guide (used in Clean Track models)	1	NC261	
16. Track silencer	2	V2530	
17. Tempered glass (glazed units)	4		
18. Glazing vinyl	64 ft.		
19. Top door frames	2	SSI-75	
20. Side and bottom door frames	14	SSI-76	
21. Corner angles	16	SS252	
22. #8-32 x 1/2" FH MS	32	301	
23. Header brackets	2	SS250	

When Ordering Repair Parts, Please Give The Following Information:

1. Part Number
2. Part Name
3. Model Number
4. Specify design, if any

## Step 1

MODELS 690B / 772B

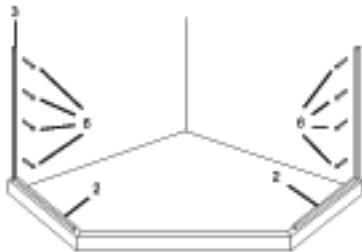

- place panel wall channels (3) on curb next to wall where stationary panels are to be installed, making sure threshold is centered on curb.
- plumb wall channels and mark installation holes on wall.
- remove all parts.
- for ceramic tile installation, use a 3/16" masonry bit for drilling installation holes and install plastic wall anchors (5).
- for fiberglass installation, use a 1/8" drill bit for drilling installation holes.
- replace wall channels (3) in previous location.
- secure wall channels to wall with four #8 x 1" truss head sheet metal screws (4).

## Step 2

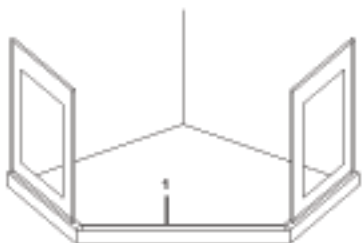

- cut sill channels (2) 1/8" less than panel width. Apply sealant to underside of sill channel (2) where channel meets wall and corner post assembly (8) and apply sealant to underside of channel to secure to curb.
- place stationary panels into sill and wall channels.
- cut by-pass-door track (1) 3/16" less than opening.
- center track (1) on curb and mark location.

## Step 3

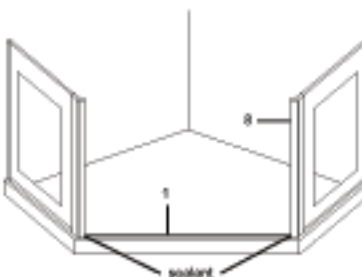

- apply sealant to underside of track where track meets wall and corner post assembly (8).
- replace track in previous location.
- Note:** secure bumpers (7) to channel (8) with sealant.

## Step 4

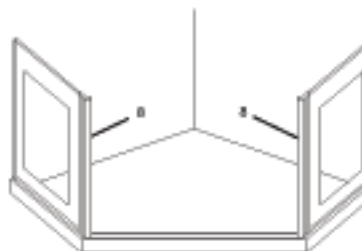

- set corner post assembly (8) onto stationary panel and over by-pass-door track.
- mark post location.
- plumb corner post assembly to stationary panel and align stationary panel.
- secure corner post assembly to panel and panels to wall channels by drilling 3/32" holes and using #6 x 3/8" pan head sheet metal screws (4).

## Step 5

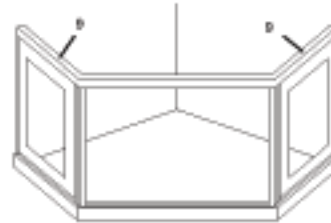

- from long point of miter, cut headers (9) 1/2" longer than centerline measurement +/- wall variance.  
**Note:** center header is cut to size at the factory.
- secure from inside of shower by drilling 3/32" holes from header into wall channels (3) and using #6 x 3/8" pan head sheet metal screws (4).
- plumb post assembly to by-pass doors.
- measure from top of wall channels (3) and cut by-pass-door header (9) to size.
- secure from inside of shower header by drilling 3/32" holes from header into wall jambs and using #6 x 3/8" pan head sheet metal screws (4).

## Step 6

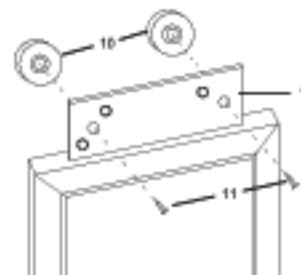

- attach rollers (10) to top of doors (16) with four #8-32 x 3/8" truss head machine screws (11) as shown.

## Step 7

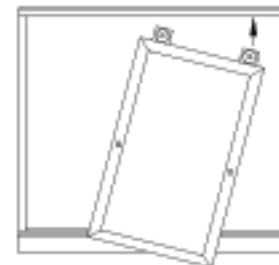

- lift inside door into header, placing rollers down in track.
- fit panel to wall by adjusting rollers.  
**Note:** Inside panel must be adjusted to the wall with the shower head.
- use the same procedure for outside door.

## Step 8

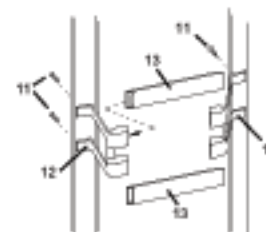

- insert towel bar brackets (12) onto towel bar ends (13).
- insert #8-32 x 3/8" truss head machine screw (11) through door and into towel bar bracket (12).
- towel bar is to be attached to the outside of the outside door and to the inside of the inside door to allow the doors to pass each other freely.

## Step 9

- seal inside and outside of unit at any point unit meets wall or curb.