

CRAFT DISTON

Biscayne Series Tub/Shower Enclosure

INSTALLATION INSTRUCTIONS

Model Numbers

Tub Enclosure 670B	Shower Enclosure 773B
-----------------------	--------------------------

(2) by-passing doors with (1) in-line panel

To install your shower enclosure, you will need the following:

- level
- 3/32", 1/8" and 3/16" drill bits
- phillips screwdriver
- sealant

GLAZED
includes glass



KD
does not
include glass



NOTE: K.D. units include all metal parts and hardware, but do not include glass. Glass size equals frame size less 1 1/2" in height and width.

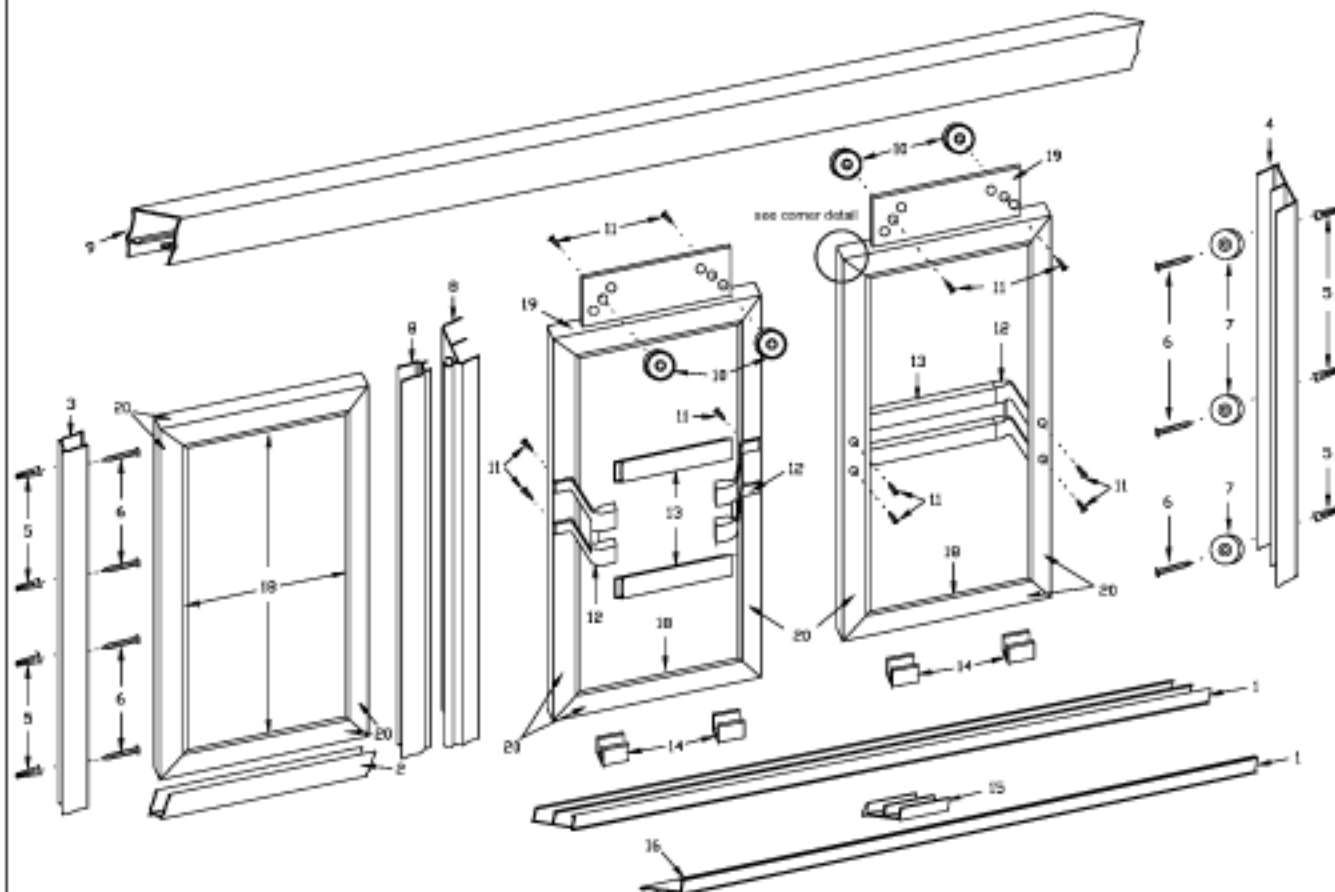

Corner Detail

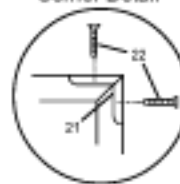

Description	Qty.	Part #	
1. Track (part # SSI-122 used in Clean Track models)	1 or 1	SSI-64 SSI-122	
2. Sill channel	1	SSI-97	
3. Panel wall channel	1	SSI-97	
4. By-pass-door wall jamb	1	SSI-90	
5. Wall anchors	7	NO240	
6. #8 x 1" TH SMS	7	300	
7. Bumpers	6	NO220	
8. Corner post assembly	1	SSI-90M97F	
9. Header	1	SSI-226	
10. Rollers	4	NO260	
11. 8-32 x 3/8" TH MS	12	302	
12. Towel bar brackets (double)	4	212	
13. Towel bars	4	SSI-40	
14. Nylon door guides (used in Standard Track models)	4	NO230	
15. Vinyl door guide (used in Clean Track models)	1	NO261	
16. Track silencer	2	V2530	
17. Tempered glass (glazed units)	3		
18. Glazing vinyl	87 ft.		
19. Top door frames	2	SSI-75	
20. Side and bottom door frames	10	SSI-76	
21. Corner angles	12	SS252	
22. #8-32 x 1/2" FH MS	24	301	
23. #8 x 3/8" PH SMS	10	205	

When Ordering Repair Parts, Please Give The Following Information:

1. Part Number
2. Part Name
3. Model Number
4. Specify design, if any

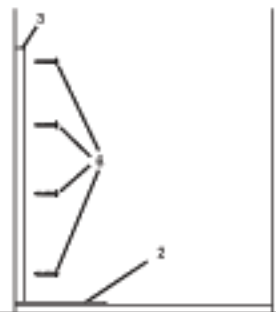

Step 1

MODEL 670B / 773B

- place panel wall channel (3) on curb next to wall where stationary panel is to be installed.
- plumb wall channel and mark installation holes on wall.
- remove all parts.
- for ceramic tile installation, use a 3/16" masonry bit for drilling installation holes and install plastic wall anchors (5).
- for fiberglass installation, use a 1/8" drill bit for drilling installation holes.
- cut sill channel (2) 1/5/8" less than panel width
- apply sealant to underside of sill channel (2) where channel meets wall and post assembly (8).

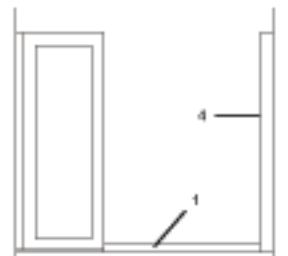

Step 2

- replace wall channel (3) in previous location.
- secure wall channel to wall with four #8 x 1" truss head sheet metal screws (6).
- place stationary panel into sill and wall channels.
- cut by-pass-door track (1) 3/16" less than opening.
- center track on curb and mark location.
- place by-pass-door wall jamb (4) on track and next to wall.
- plumb wall channel and mark installation holes on wall.

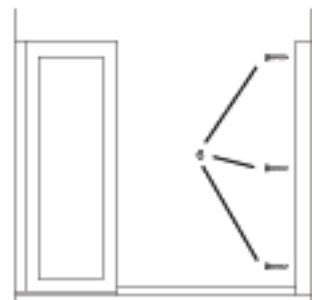

Step 3

- remove all parts.
- for ceramic tile installation, use a 3/16" masonry bit for drilling installation holes and install plastic wall anchors (5).
- for fiberglass installation, use a 1/8" drill bit for drilling installation holes.
- apply sealant to underside of track where track meets wall and corner post assembly (8).
- replace track and wall channel in previous location.
- secure wall channel to wall with three #8 x 1" truss head sheet metal screws (6).

Note: secure bumpers (7) to wall jamb (4) with installation screws on wall side and sealant on panel side.

Step 4

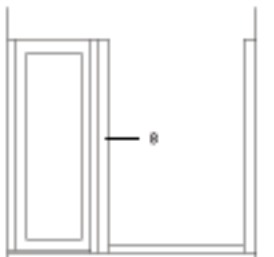

- set in-line post assembly (8) onto stationary panel and over by-pass-door track.
- plumb post assembly to stationary panel and align stationary panel.
- secure post assembly to panel by drilling 3/32" holes and using #6 x 3/8" pan head sheet metal screws (23).

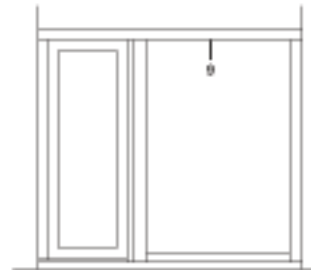

Step 5

- measure across top of unit and cut by-pass-door header (9) to size.
- secure header by drilling 3/32" holes from header into wall jambs and using #6 x 3/8" pan head sheet metal screws (23).

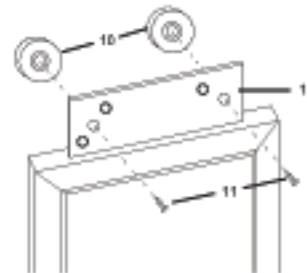

Step 6

- attach rollers (10) to top of doors (19) with four #8-32 x 3/8" truss head machine screws (11) as shown.

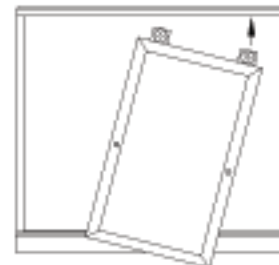

Step 7

- lift inside door into header, placing rollers down in track.
 - fit panel to wall by adjusting rollers.
- Note:** Inside panel must be adjusted to the wall with the shower head.
- use the same procedure for outside door.

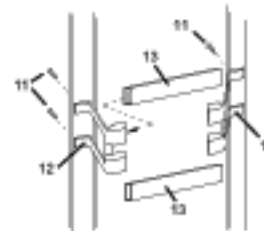

Step 8

- insert towel bar brackets (12) onto towel bar ends (13).
- insert #8-32 x 3/8" truss head machine screw (11) through door and into towel bar bracket (12).
- towel bar is to be attached to the outside of the outside door and to the inside of the inside door to allow the doors to pass each other freely.

Step 9

- seal inside and outside of unit at any point unit meets wall or curb.