

CRAFT DISTON

Capri Series Tub/ Shower Enclosure

INSTALLATION INSTRUCTIONS

Model Numbers

Tub Enclosure 58C	Shower Enclosure 76C
----------------------	-------------------------

(2) by-passing doors

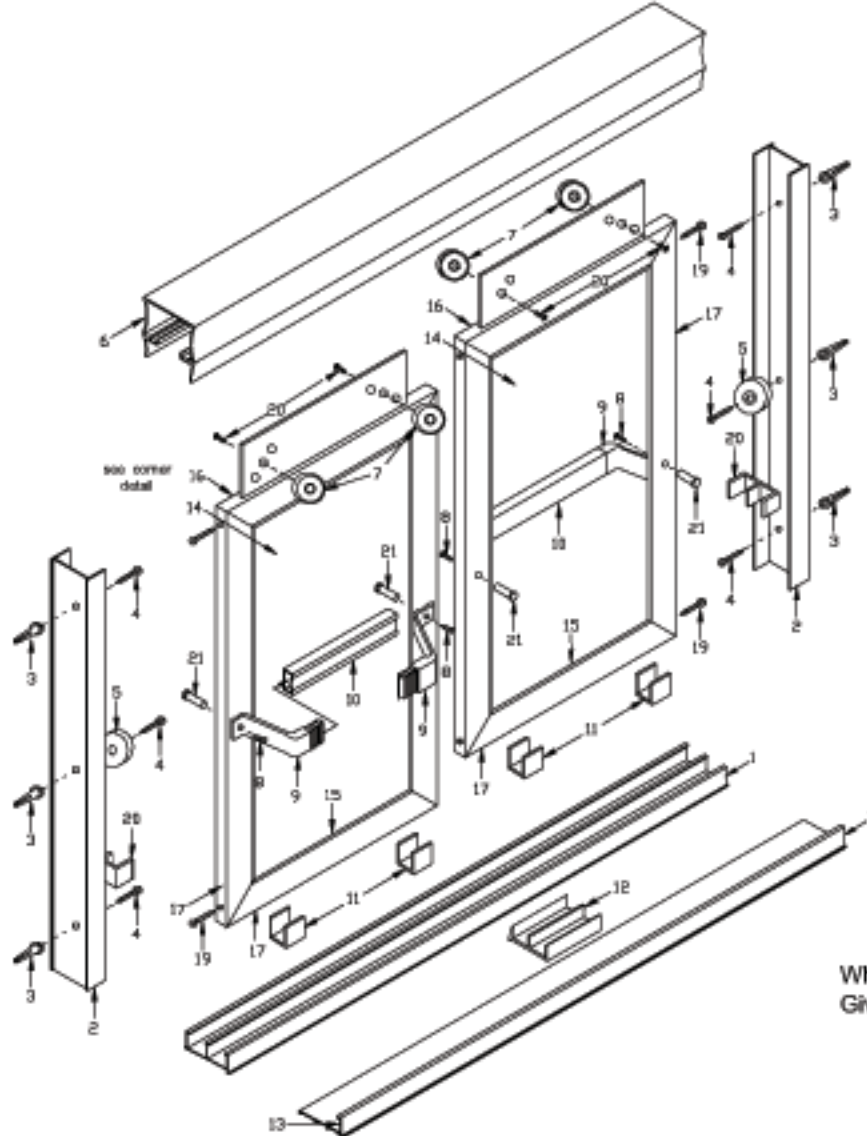

To install your shower enclosure, you will need the following:

- level
- 3/32", 1/8" and 3/16" drill bits
- phillips screwdriver
- sealant

GLAZED
includes glass

KD
does not
include glass

NOTE: K.D. units include all metal parts and hardware, but do not include glass. Glass size equals frame size less 1 1/2" in height and width.

Description	Qty.	Part #	
1. Track (part # SSI-122 used in Clean Track models)	1 or 1	SSI-64 SSI-122	
2. Wall jambs	2	SSI-163	
3. Wall anchors	6	NO240	
4. #8 x 1" PH SMS	6	300	
5. Bumpers	2	NO220	
6. Header	1	SSI-226	
7. Rollers	4	NO260	
8. #6-32 x 1/2" TH MS	4	305	
9. Towel bar brackets (Single)	4	210	
10. Towel bars	2	CFM-40	
11. Nylon door guides (used in standard Track models)	4	NO230	
12. Vinyl door guide (used in Clean Track Models)	1	NO261	
13. Track slencer (used in Clean Track Models)	2	V2630	
14. Tempered glass (glass units)	2		
15. Glazing vinyl	28 ft.		
16. Top door frames	2	SSI-75	
17. Side & bottom door frames	6	SSI-76	
18. Corner brackets	8	SS252	
19. #8-32 x 1/2" FH MS	16	301	
20. 8-32 x 3/8 TH SMS	4	302	
21. Screw jackets	4	303	

When Ordering Repair Parts, Please Give The Following Information:

1. Part Number
2. Part Name
3. Model Number
4. Specify design, if any

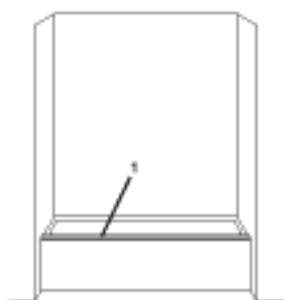

Step 1

MODELS 58C / 76C

Standard track models

- measure the wall to wall opening on tub rim.
- cut track (1) 3/16" less than opening width.

Clean track models

- position vinyl guide (12) in the exact center of track with track silencer (13) lightly against either side of vinyl guide.
- trim excess at each end of track.

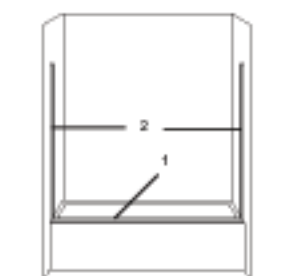

Step 2

- place track (1) on center of tub rim with weep holes to inside of shower.
- set jamba (2) firmly in track next to wall.
- plumb and mark installation holes on wall.

Note: It is important that the wall jamba are plumb

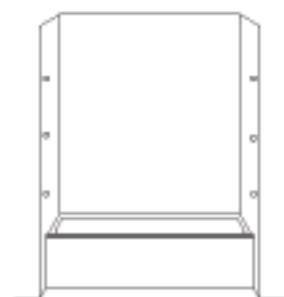

Step 3

- remove all parts.
- for ceramic tile installation, use a 3/16" masonry bit for drilling installation holes and install plastic wall anchors (3).
- for fiberglass walls, use a 9/64" drill bit for drilling installation holes.

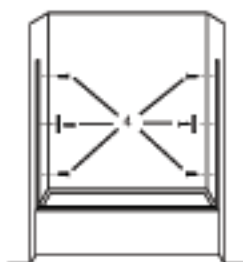

Step 4

- apply a continuous bead of sealant to the underside of track (1).
 - replace track in previous location and apply sealant to both ends where track meets wall.
 - replace jamba (2) and secure to wall with six #8 x 1" pan head sheet metal screws (4).
- NOTE: Use center screws to install bumpers (5).

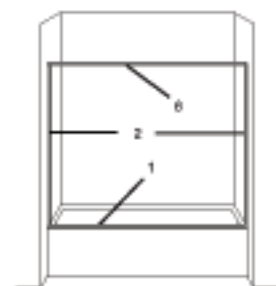

Step 5

- measure the wall to wall opening above the wall jamba.
- cut header (8) 1/16" less than opening.
- place header over jamba (2).

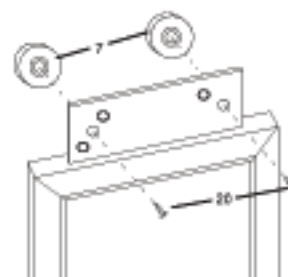

Step 6

- attach rollers (7) to top of doors with four #8-32 x 3/8" truss head machine screws (20) as shown.



Step 7

- lift door into header, placing rollers down in track. Do the same for other door.

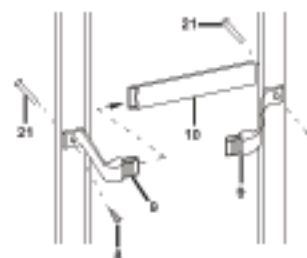

Step 8

- insert towel bar brackets (9) into towel bar ends (10).
- insert #8-32 x 1/2" truss head machine screw (8) through towel bar bracket (9) and side frame of door and into screw jacket (21).
- towel bars are to be attached to the outside of the outside door and to the inside of the inside door to allow the doors to pass each other freely.

Step 9

- seal inside and outside of unit at any point unit meets wall or curb.