

CRAFT DISTON

Deluxe Series Pivoted Shower Enclosure

INSTALLATION INSTRUCTIONS

Model Numbers

SHOWER ENCLOSURES
 340 65 1/2" Height
 350 69 1/2" Height

GLAZED
 includes glass

KD
 does not
 include glass

To install your shower enclosure, you will need the following:

- Level
- 3/32", 9/64", 1/8" and 3/16" Drill Bits
- Phillips Screwdriver
- Sealant

Corner Detail

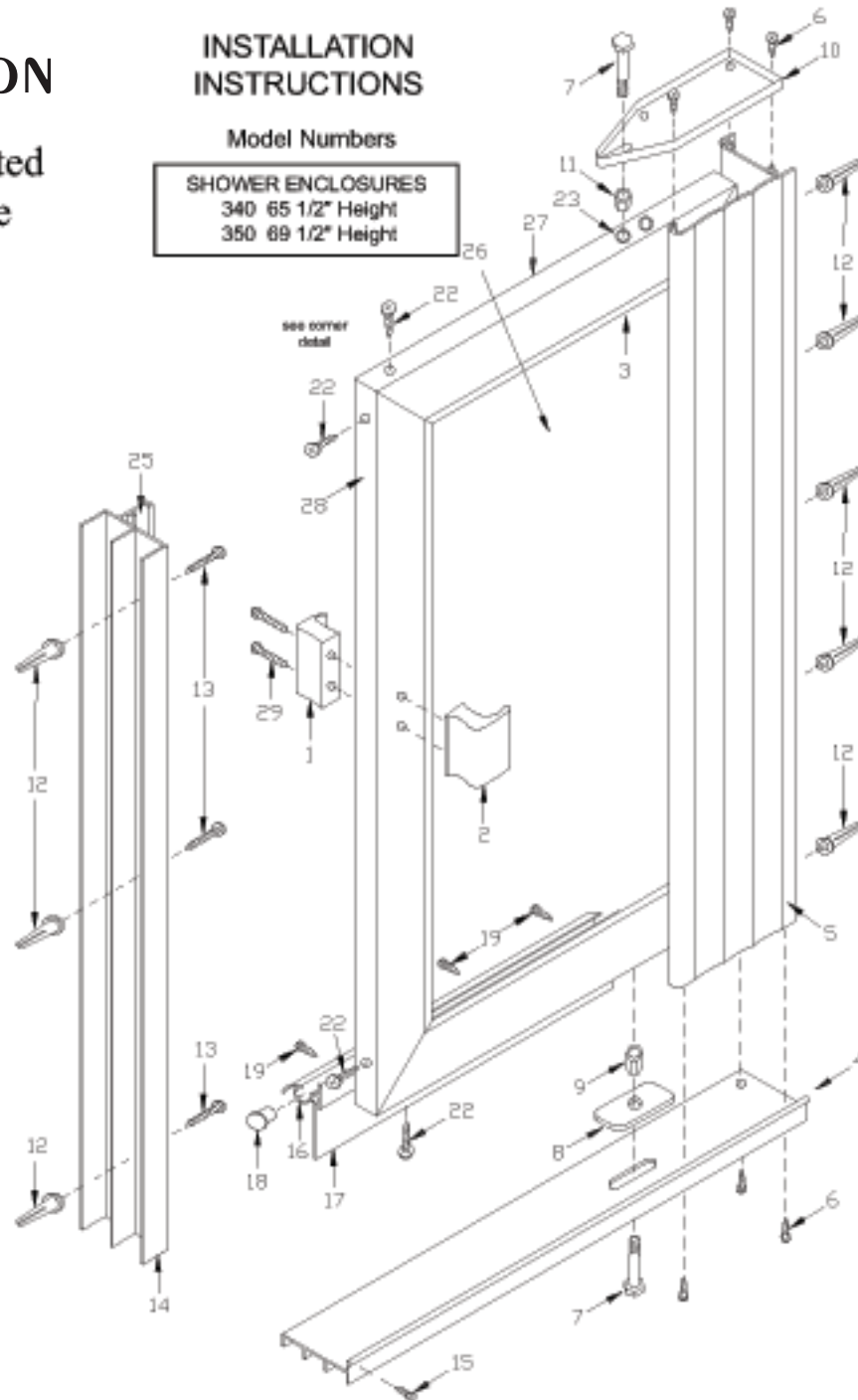

NOTE: K.D. units include all metal parts and hardware, but do not include glass.

Description	Qty.	Part #	
1. Inside door handle	1	Q53439	
2. Outside door handle	1	Q53440	
3. Glazing vinyl	16 ft.		
4. Pivot threshold	1	CFM-31	
5. Wide pivot jamb	1	CFM-30	
6. #8 x 1/2" PH SMS	6	305	
7. Pivot bolts - 1/4 x 1 x 20	2	SS420	
8. Cover plate	1	A814	
9. Nylon spacer nut - 1/4 x 1/2	1	NO320	
10. Top pivot bracket	1	9505	
11. Top spacer nut - 1/4 x 1/4	1	SS430	
12. Wall anchors	8	NO240	
13. #10 x 1 1/2" FH SMS	8	311	
14. Stille jamb	1	CFM-85	
15. #6 x 1/2" PH SMS	1	310	
16. Drip channel	1	CFM-49	
17. Drip channel vinyl	1	V1596	
18. Drip channel plug	1	NO312	
19. #6 x 3/8" PH SMS	3	205	
21. Corner angles	4	191-1-1	
22. #8-32 x 1/2" FH SMS	10	301	
23. Nylon bushings	4	SB-375	
24. Pivot jamb splash vinyl	1	V2067	
25. Magnetic strip	2	M-1354	
26. Tempered glass	1		
27. Door frame	3	CFM-901	
28. Magnetic glass frame	1	CFM-983	
29. #6-32 X 1 3/4" FHMS	2	903	

When Ordering Repair Parts, Please Give The Following Information:

1. Part Number
2. Part Name
3. Model Number
4. Specify design, if any

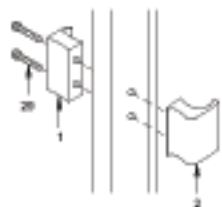

Step 1

Assemble door handles

Models 340 / 350

- attach outside door handle (2) and inside door handle (1) to door with two #8-32 x 1/2" flat head machine screws (29).
- set door assembly aside. (The inside door handle should be placed on the magnet side of the door.)

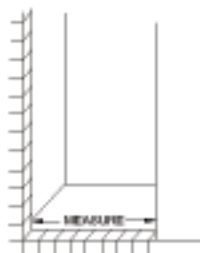

Step 2

- this door is reversible and can swing to the right or left. (A right-swing door is shown.) Decide which way you wish your door to swing.
 - measure the wall to wall opening of the shower curb.
 - cut bottom threshold (4) 1/16" less than opening width, leaving pivot slot and screw holes on pivot side.
- Note:** Make sure high side of threshold is to the outside of shower.

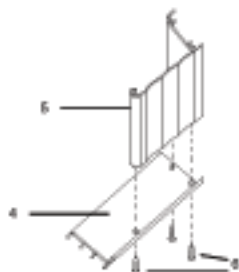

Step 3

- attach threshold (4) to wide pivot jamb (5) using three #8 x 1/2" pan head sheet metal screws (8).

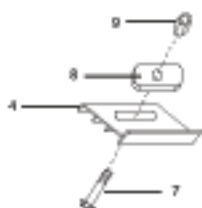

Step 4

- insert pivot bolt (7) into threshold (4) pivot slot.
- place cover plate (8) onto bolt.
- thread nylon spacer (9) nut onto bolt.
- the bolt should be snug, but not tight.

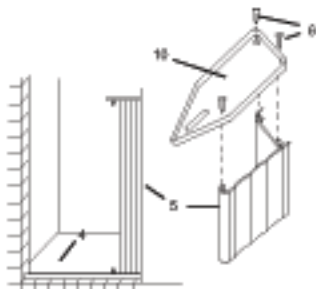

Step 5

- attach top pivot bracket (10) to wide pivot jamb (5) using three #8 x 1/2" pan head sheet metal screws (8).
- start bolt (7) into top spacer nut (11), do not tighten.
- position pivot jamb on wall.
- plumb pivot jamb and mark installation holes on wall.
- remove all parts
- for ceramic tile installation, use a 3/16" masonry bit for drilling installation holes and install plastic wall anchors (12).
- for fiberglass installation, use a 9/64" drill bit for drilling installation holes.

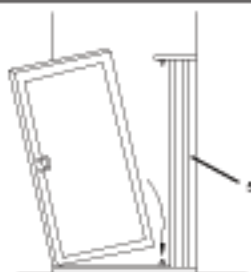

Step 6

- replace sill and jamb assembly in previous location.
- secure wide pivot jamb (5) to wall with three #8 x 1 1/2" pan head sheet metal screws (13).
- determine which pivot hole in door is to be used and set door into bottom bolt.
- thread top bolt (7) into pivot hole in top of door.

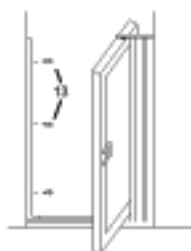

Step 7

- position strike jamb (14) on threshold, make sure threshold is even on curb.
- close door against strike jamb making sure door fits flush against jamb.
- mark holes on wall.
- remove strike jamb.
- using a 3/16" masonry bit, drill installation holes and install plastic wall anchors (12).
- replace strike jamb (14), secure to wall with three #8 x 1 1/2" pan head sheet metal screws (13).

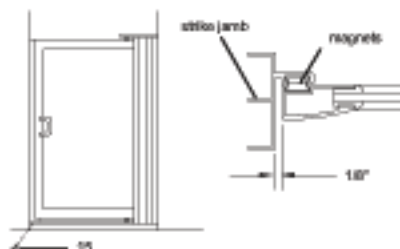

Step 8

- anchor strike jamb (14) to threshold with one #8 x 1/2" pan head sheet metal screw (15).
 - adjust door to opening and tighten both the bottom and top pivot bolts (7).
- NOTE:** If magnet does not pull door shut, reverse strike jamb magnet. Groove in magnets should match.

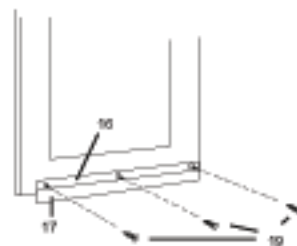

Step 9

- cut drip channel (16) 1/2" less than panel width.
 - insert drip channel vinyl (17) into drip channel (16) and trim to size.
 - insert plastic drip channel plug (18) into end of drip channel.
 - with door closed, position drip channel on inside of door with a slope to the pivot side.
 - Mark the location, then clean door thoroughly with rubbing alcohol.
 - peel protective cover off double face tape and install drip channel to inside of door with a slope to the pivot side.
 - for additional security, drill three 3/32" holes from drip channel into door.
 - secure with three #6 x 3/8" pan head sheet metal screws (19).
- IMPORTANT:** holes must be drilled a minimum of 3/8" below exposed glass.

Step 10

- seal with silicone the inside and outside of pivot jamb, strike jamb and threshold.
- A bead of silicone will be needed where pivot jamb and strike jamb meet the threshold.