

CRAFT DISTON

Model 883TR Quikstik Shower Enclosure Panel on Tile Rise

NOTE: all doors are completely reversible and may be installed hinge-left or hinge-right and can be hinged from the wall or from 90° post. These illustrations show a hinge-right door hinging from the wall. Other combinations are installed in a similar manner.

To install your shower enclosure, you will need the following:

- Level
- 3/32", 9/64" and 3/16" Drill Bits
- Phillips Screwdriver
- Sealant
- Hack Saw

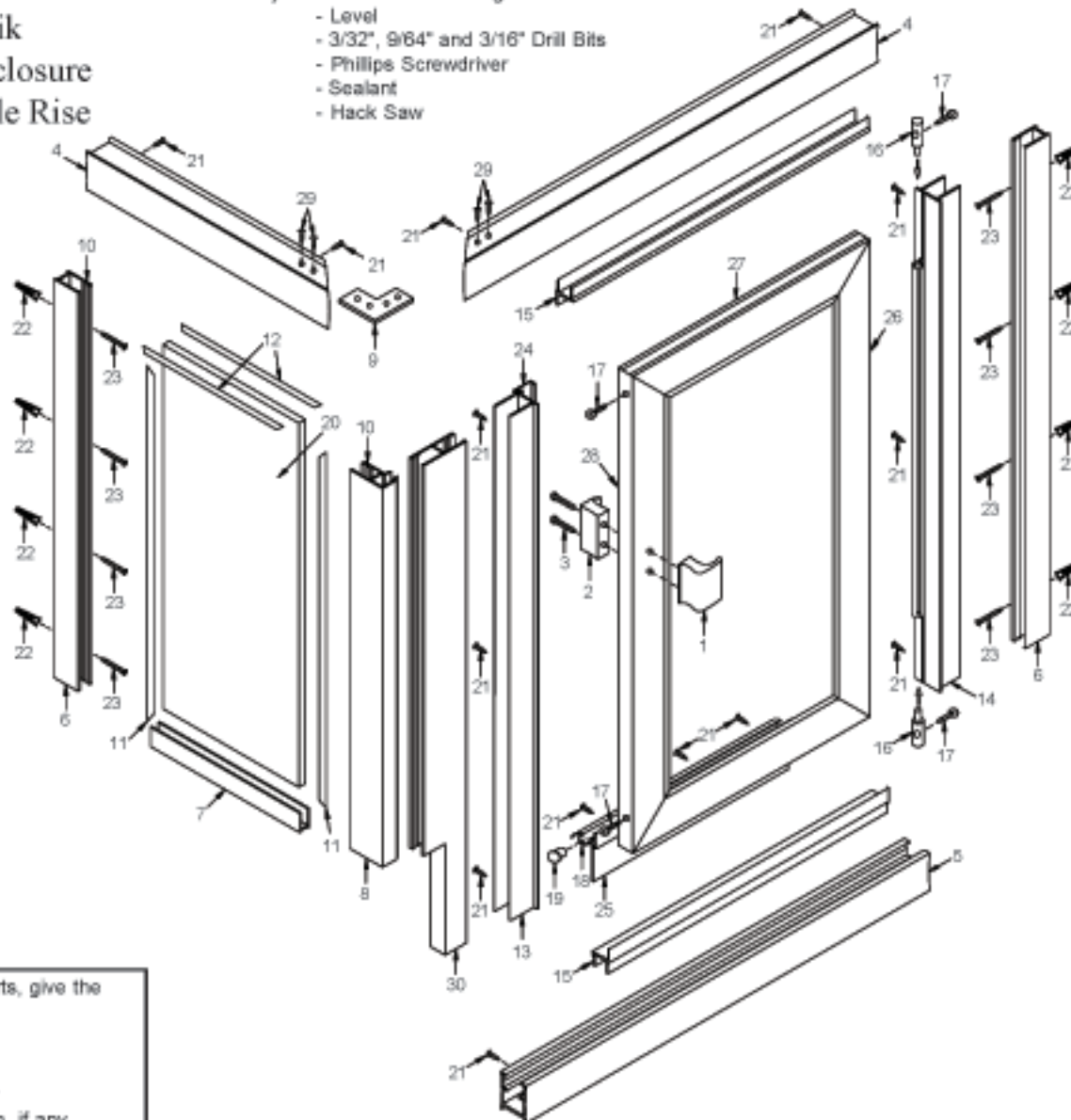

When ordering repair parts, give the following information:

1. Part Number
2. Part Name
3. Model Number
4. Specify design, if any

DESCRIPTION	QTY.	PART#	
1. Outside door handle	1	QS3438	
2. Inside door handle	1	QS3440	
3. #6-32 X 1 3/4" FHMS	2	903	
4. Headers	2	CFM-834H	
5. Sills (with weep holes)	2	CFM-834S	
6. Wall channels	2	CFM-863	
7. Butress glass channel	1	CFM-904	
8. 90° butress post	1	CFM-938	
9. 90° angle	1	PP250	
10. Inside vertical vinyls	2	QS8037VL	
11. Outside vertical vinyls	2	QS3114VL	
12. Inside and outside horizontal vinyls	2	QS194VL	
13. Strike jamb	1	CFM-854	
14. Hinge jamb	1	CFM-908	
15. Thresholds	2	CFM-902	
16. Hinge pins	2	EHB-1	
17. #7 x 1 1/4" FH SMS	4	7125	
18. Drip channel	1	CFM-49	
19. Drip channel plug	1	DF-312	
20. Glass panels	2		
21. #6 x 1/2" PH SMS	14	310	
22. Wall anchors	8	NC240	
23. #6 x 1 1/2" OH SMS	8	902	
24. Magnetic strips	2	M1354	
25. Drip channel vinyl	1	V1586	
26. Hinge glass frame	1	CFM-807	
27. Horizontal glass frames	2	CFM-910	
28. Magnetic glass frame	1	CFM-983	
29. #8 x 1/2" PH SMS	4	306	
30. H mullion	1	CFM-903	
31. Glazing vinyl	17'		

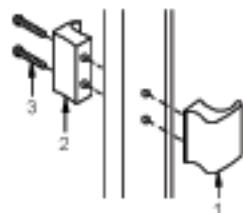

Step 1

Model 883TR

Assemble door handles

- attach outside door handle (1) and inside door handle (2) to door with two #8-32 x 1 3/4" flat head machine screws (3).
- (The inside door handle should be placed on the magnet side of the door.)

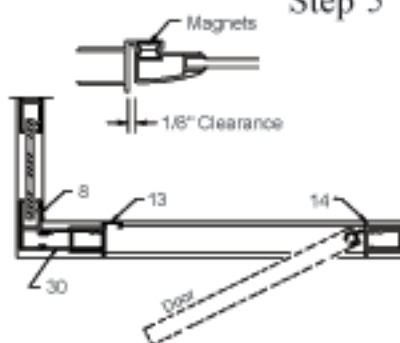

Step 5

- This door is reversible and can swing to the right or left. Decide which way you wish your door to swing. (A right-swing door is shown.)
- position strike jamb (13) over H mullion (30) with long side to inside of shower.
 - position hinge jamb (14) with door on wall channel (6).
 - close door against strike jamb making sure door is flush against jamb and align door to opening.
- Note:** if magnet does not pull door shut, reverse strike jamb magnet. Groove in magnet should match.



Step 2

- cut sill (5) to size (centerline measurement - 1/16").
- cut headers (4) to size (centerline measurement + 1/2" to long point of miter +/- wall variance.)
- assemble the two headers (4) by inserting the 90 degree angle (8) into mitered ends.
- secure 90 degree angle with four #8 x 1/2" pan head sheet metal screws (29).
- place sill on center of curb with weep holes to inside of shower.
- set wall channels (6) into position next to wall. Make sure wall channel with vinyl is installed on the wall that will receive the glass panel and vinyl is to inside of shower.
- plumb and mark installation holes on wall.
- remove all parts.
- for ceramic tile installation, use a 3/16" masonry bit for drilling installation holes and install plastic wall anchors (22).
- for fiberglass walls, drill 5/64" holes.

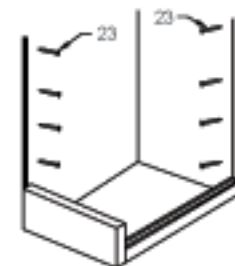
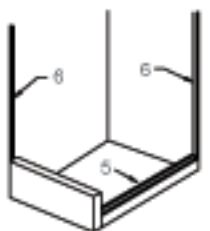

Step 3

- place a bead of sealant on each end of curb under sill location.
- replace sill (5) in previous location.
- replace wall channels (6) and secure to wall with eight #8 x 1 1/2" pan head sheet metal screws (23).

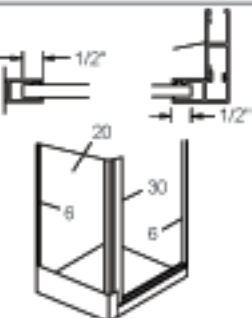

Step 4

- place butress glass channel (7) on bottom of glass.
- set the 90 degree glass panel (20) into position.
- place the 90 degree butress post (8) into position with vinyl over glass and to the inside of shower. The glass will penetrate wall channel and 90 degree butress post approximately 1/2".
- snap H mullion (30) on to butress post.

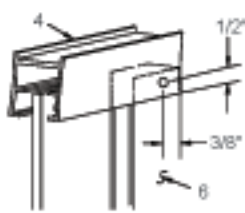

Step 6

- place header (4) over wall channels (6) and 90 degree butress post (8) and H mullion (30).
 - secure header to wall channels by drilling 3/32" holes from inside of header into wall channels as shown.
- IMPORTANT:** note the location of glass before drilling, the drill bit must not hit the glass.
- from inside shower, secure 90 degree post (8) to header and sill by drilling 3/32" holes from inside header and sill into 90 degree post.
 - secure with #8 x 1/2" pan head sheet metal screws (21).

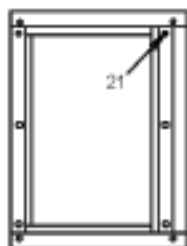
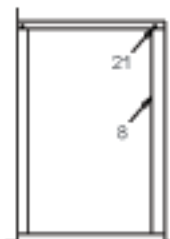

Step 7

- align unit to opening.
- from inside unit, secure strike jamb (13) to H mullion (30) and hinge jamb (14) and door to wall channel (6) by drilling 3/32" holes approximately 3/8" from each end and in the center.
- secure with #8 x 1/2" pan head sheet metal screws (21).



Step 8

- measure between hinge (14) and strike (13) jambs and cut both thresholds to size.
- with high side of threshold (15) to outside, snap threshold into header (4) and sill (5).

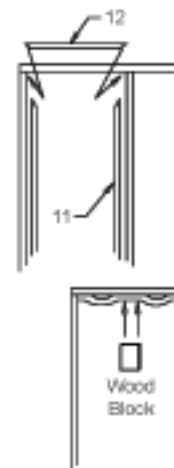

Step 9

- check panel glass alignment and install outside vertical wedge (11).
- NOTE:** a lubricant such as WD-40 or hand lotion can be used to assist wedge vinyl installation. A block of wood is helpful for installing wedge vinyl.
- cut horizontal wedge vinyl (12) slightly longer than needed (approx. 1/8") and at a 45 degree angle.
 - install inside and outside horizontal wedge vinyl into header and sill by starting vinyl at each end, then work from center to each end.

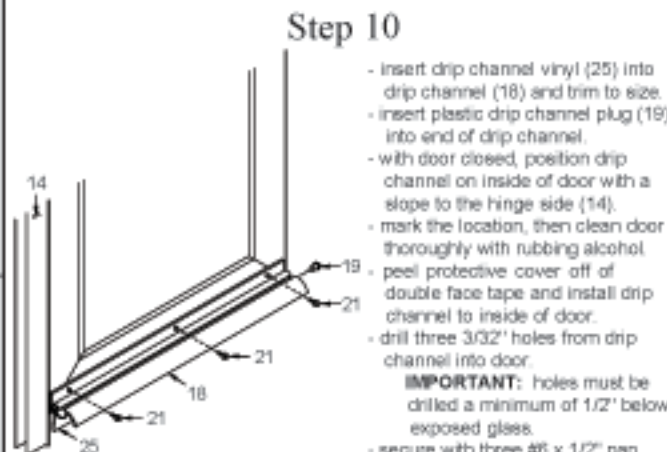

Step 10

- insert drip channel vinyl (25) into drip channel (18) and trim to size.
 - insert plastic drip channel plug (19) into end of drip channel.
 - with door closed, position drip channel on inside of door with a slope to the hinge side (14).
 - mark the location, then clean door thoroughly with rubbing alcohol.
 - peel protective cover off of double face tape and install drip channel to inside of door.
 - drill three 3/32" holes from drip channel into door.
- IMPORTANT:** holes must be drilled a minimum of 1/2" below exposed glass.
- secure with three #8 x 1/2" pan head sheet metal screws (21).

Step 11

- seal inside and outside of unit at any point unit meets wall and curb. Also seal inside and outside glass where glass meets CFM-904, butress glass channel (7)