

# CRAFT DISTON

## Model 882TR With Snap Jamb Quikstik Shower Enclosure

To install your shower enclosure,  
you will need the following:

- level
- 3/32" and 3/16" drill bits
- phillips screwdriver
- sealant

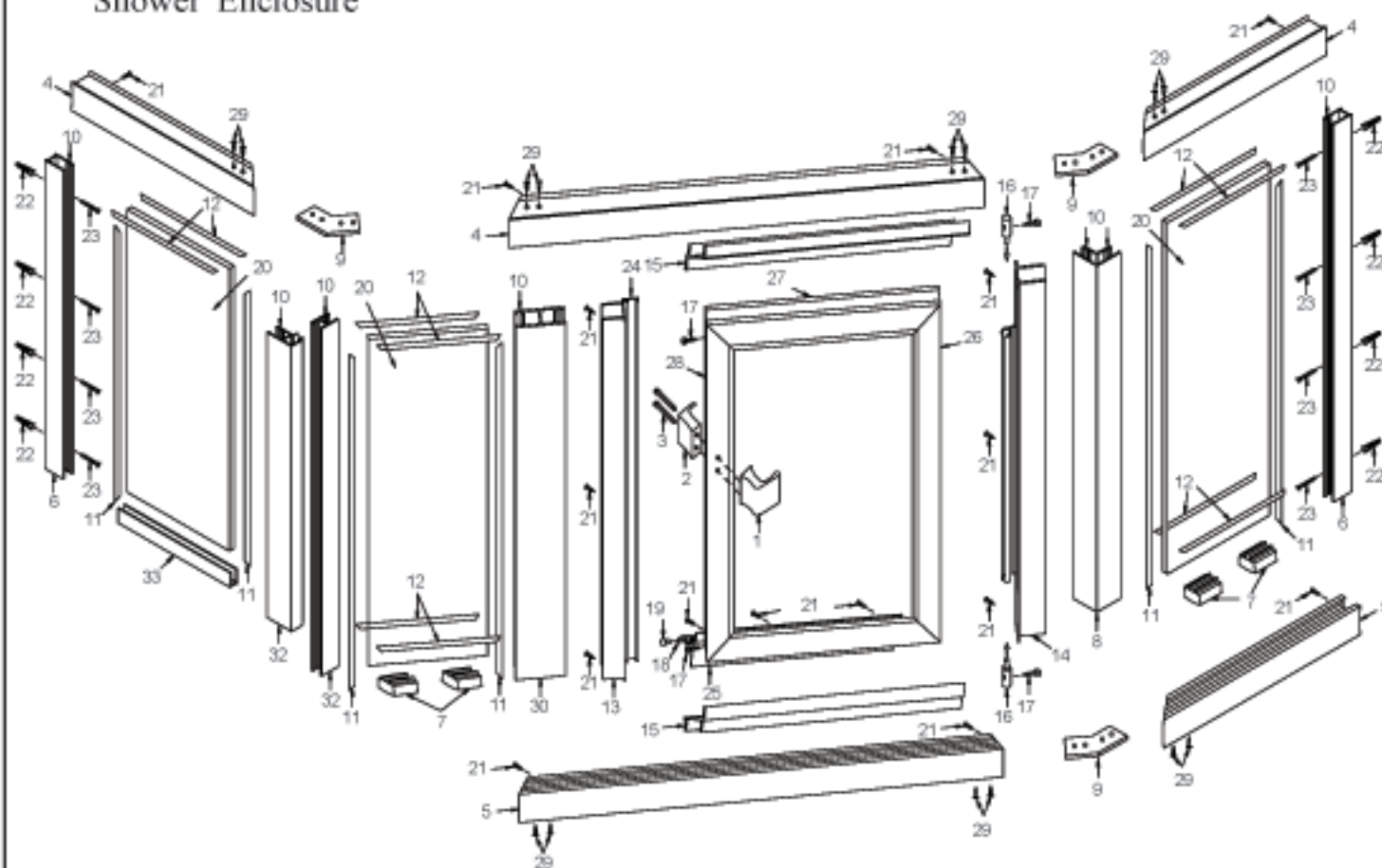

When ordering repair parts, give the  
following information:

1. Part Number
2. Part Name
3. Model Number
4. Specify design, if any

NOTE: all doors are completely reversible and may be installed hinge-left or hinge-right and can be hinged from the wall, H mullion or 90° post. These illustrations show a hinge-right door hinging from the 90° post. Other combinations are installed in a similar manner.

DESCRIPTION	QTY.	PART#	
1. Outside door handle	1	QS3438	
2. Inside door handle	1	QS3440	
3. #6-32 X 1 3/4" FHMS	2	903	
4. Headers	3	CFM-834-H	
5. Sills (with weep holes)	2	CFM-934S	
6. Wall channels	2	CFM-853	
7. Setting blocks	6	QS8110VL	
8. 90° posts	2	CFM-867	
9. 90° angles	3	PP250	
10. Inside vertical vinyls	6	QS8037VL	
11. Outside vertical vinyls	6	QS3114VL	
12. Inside and outside horizontal vinyls	12	QS194VL	
13. Strike jamb	1	CFM-654	
14. Hinge jamb	1	CFM-908	
15. Thresholds	2	CFM-902	
16. Hinge pins	2	B-B-1	
17. #7 x 1 1/4" FH SMS	4	7125	
18. Drip channel	1	CFM-49	
19. Drip channel plug	1	DP-312	
20. Glass panels	4		
21. #6 x 3/8" PH SMS	22	205	
22. Wall anchors	8	NC240	
23. #8 x 1 1/2" OH SMS	8	902	
24. Magnetic strips	2	M1354	
25. Drip channel vinyl	1	V1585	
26. Hinge glass frame	1	CFM-807	
27. Horizontal glass frames	2	CFM-910	
28. Magnetic glass frame	1	CFM-663	
29. #6 x 1/2" PH SMS	16	306	
30. H mullion	1	CFM-903	
31. Glazing vinyl	17'		
32. 90° buttress post	1	CFM-939& CFM-905	
33. Buttress glass channel	1	CFM-904	

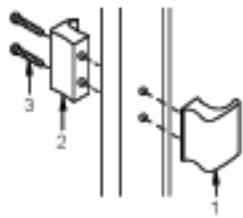

## Step 1

Model 862TR  
with snap jamb

Assemble door handles

- attach outside door handle (1) and inside door handle (2) to door with two #6-32 x 1 3/4" flat head machine screws (3).  
(The inside door handle should be placed on the magnet side of the door.)

## Step 2



- cut panel headers (4) and sills (5) to size (centerline measurement + 1/2" to long point of miter +/- wall variance.) Door and in-line panel sills and headers are normally cut to size at the factory. If not, cut to size (centerline measurement + 1" to long points of mitres.)

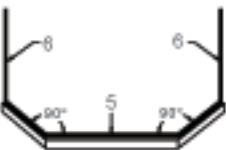

- insert two setting blocks (7) into each sill (5). (Glass will be placed on setting blocks.)
- assemble the three sills (5) and headers (4) by inserting the 90 degree angle (8) into mitered ends.

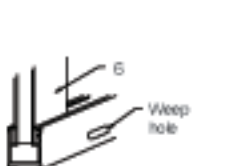

- secure 90 degree angle with four #8 x 1/2" pan head sheetmetal screws (29).
- place sill on center of curb with weep holes to inside of shower.
- set wall channels (6) firmly on sill (5) next to wall. Make sure wall channel with vinyl is installed on the wall that will receive the glass panel and vinyl is to inside of shower.
- plumb and mark installation holes on wall.
- remove all parts.
- for ceramic tile installation, use a 3/16" masonry bit for drilling installation holes and install plastic wall anchors (22).

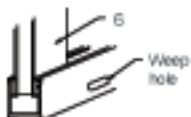

## Step 3

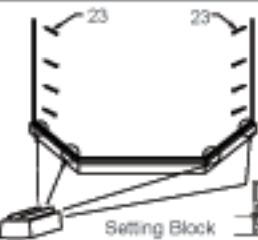

- place a bead of sealant on each end of curb under threshold location.
- replace sill (5) in previous location.

- replace wall channels (6) and secure to wall with eight #8 x 1 1/2" pan head sheet metal screws (23).

## Step 4

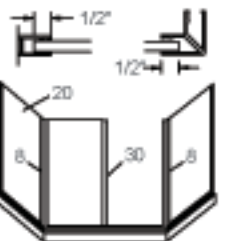

- set the 90 degree glass panel (20) into position. Setting blocks (7) should be positioned approximately 2" from each corner of glass.
- place the 90 degree post (8) into position with vinyl over glass and to the inside of shower. The glass will penetrate wall channels and 90 degree post approximately 1/2".
- repeat for other 90 degree glass panel.
- set the in-line glass panel (20) into position. Setting blocks should be positioned approximately 2" from each corner of glass.
- place H mullion (30) into position with vinyl over glass and to inside of shower.

## Step 5

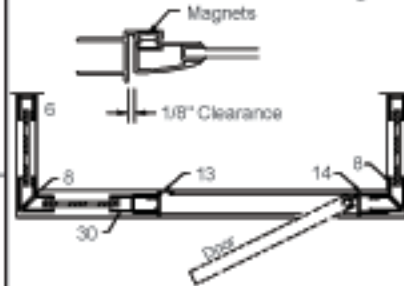

- This door is reversible and can swing to the right or left. Decide which way you wish your door to swing. (A right-swing door is shown.)
- position strike jamb (13) over H mullion (30) with long side to inside of shower.
  - position hinge jamb (14) with door on wall channel (6).
  - close door against strike

jamb making sure door is flush against jamb and align door to opening.

**Note:** if magnet does not pull door shut, reverse strike jamb magnet. Groove in magnet should match.

## Step 6

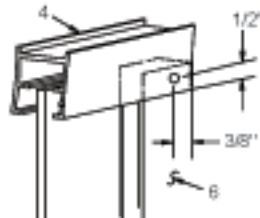

- place header (4) over wall channels (6), H mullion (30) and 90 degree posts (8).
- plumb 90 degree posts (if headers are cut correctly, 90 degree posts will be plumb).
- secure header and sill to wall channels by drilling 3/32" holes from inside of header into wall channels as shown.

**IMPORTANT:** note the location of glass before drilling, the drill bit must not hit the glass.

- from inside shower, secure H mullion (30) and 90 degree posts (8) to header and sill by drilling 3/32" holes from inside header and sill into H mullion and 90 degree post.
- secure with #6 x 3/8" pan head sheet metal screws (21).

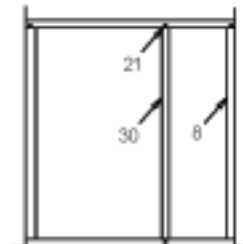

## Step 7

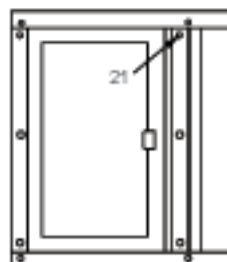

- align unit to opening
- from inside unit, secure strike jamb (12) to H mullion (8) and hinge jamb (13) and door to 90 degree post (8) by drilling 3/32" holes approximately 3/8" from each end and in the center.
- secure with #6 x 3/8" pan head sheet metal screws (21).

## Step 8

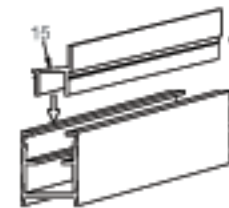

- measure between hinge (14) and strike (13) jambs and cut both thresholds to size.
- with high side of threshold (15) to outside, snap threshold into header (4) and sill (5).

## Step 9

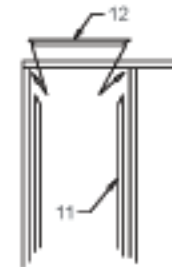

- check panel glass alignment and install outside vertical wedge (11).  
**NOTE:** a lubricant such as WD-40 or hand lotion can be used to assist wedge vinyl installation. A block of wood is helpful for installing wedge vinyl.

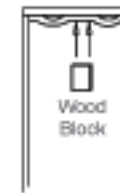

- cut horizontal wedge vinyl (12) slightly longer than needed (approx. 1/8") and at a 45 degree angle.
- install inside and outside horizontal wedge vinyl into header and sill by starting vinyl at each end, then work from center to each end.
- repeat for other glass panel.

## Step 10

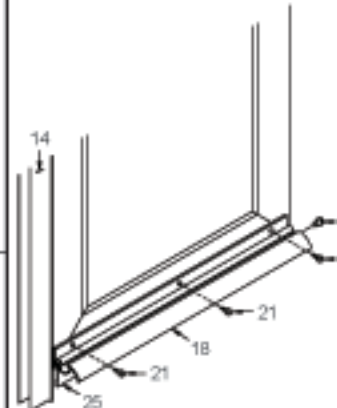

- insert drip channel vinyl (25) into drip channel (18) and trim to size.
- insert plastic drip channel plug (19) into end of drip channel.
- with door closed, position drip channel on inside of door with a slope to the hinge side (14).
- mark the location, then clean door thoroughly with rubbing alcohol.
- peel protective cover off of double face tape and install drip channel to inside of door.
- drill three 3/32" holes from drip channel into door.

**IMPORTANT:** holes must be drilled a minimum of 1/2" below exposed glass.

- secure with three #6 x 3/8" pan head sheet metal screws (21).

## Step 11

- seal inside and outside of unit at any point unit meets wall and curb.