

CRAFT DISTON

Model 842 Quikstik Shower Enclosure

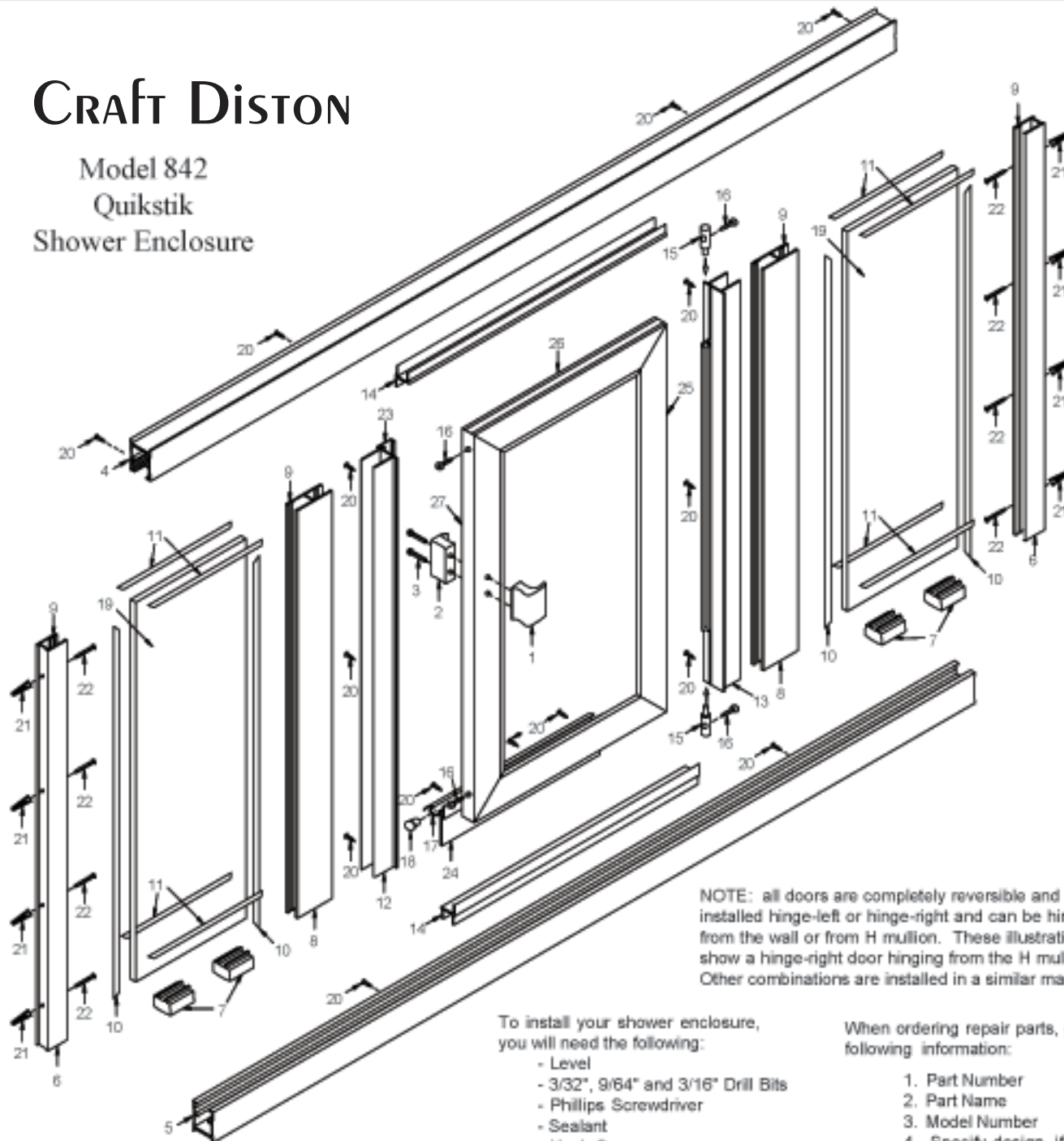

NOTE: all doors are completely reversible and may be installed hinge-left or hinge-right and can be hinged from the wall or from H mullion. These illustrations show a hinge-right door hinging from the H mullion. Other combinations are installed in a similar manner.

To install your shower enclosure, you will need the following:

- Level
- 3/32", 9/64" and 3/16" Drill Bits
- Phillips Screwdriver
- Sealant
- Hack Saw

When ordering repair parts, give the following information:

1. Part Number
2. Part Name
3. Model Number
4. Specify design, if any

DESCRIPTION	QTY.	PART#	
1. Outside door handle	1	QS3439	
2. Inside door handle	1	QS3440	
3. #6-32 X 1 3/4" FHMS	2	903	
4. Header	1	CFM-934H	
5. Sill (with weep holes)	1	CFM-934S	
6. Wall channels	2	CFM-953	
7. Setting block	4	QS9110VL	
8. H mullion	2	CFM-903	
9. Inside vertical vinyls	4	QS9037VL	
10. Outside vertical vinyls	4	QS3114VL	
11. Inside and outside horizontal vinyls	8	QS194VL	
12. Strike jamb	1	CFM-954	
13. Hinge jamb	1	CFM-908	
14. Thresholds	2	CFM-902	
15. Hinge pins	2	EHB-1	
16. #7 x 1 1/4" FH SMS	4	7125	
17. Drip channel	1	CFM-49	
18. Drip channel plug	1	DP-312	
19. Glass panels	3		
20. #6 x 1/2" PH SMS	15	310	
21. Wall anchors	8	NC240	
22. #6 x 1 1/2" CH SMS	8	902	
23. Magnetic strips	2	M1354	
24. Drip channel vinyl	1	V1595	
25. Hinge glass frame	1	CFM-907	
26. Horizontal glass frames	2	CFM-910	
27. Magnetic glass frame	1	CFM-983	
28. Glazing vinyl	17'		

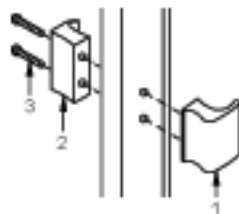

Step 1

Model 842

Assemble door handles

- attach outside door handle (1) and inside door handle (2) to door with two #6-32 x 1 3/4" flat head machine screws (3). (The inside door handle should be placed on the magnet side of the door.)

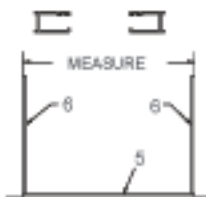

Step 2

- measure the wall to wall opening of the shower.
- cut header (4) and sill (5) 1/16" less than opening width.
- insert four setting blocks (7) into sill (5). (Glass will be placed on setting blocks.)
- place sill on center of curb with weep holes to inside of shower.
- set wall channels (6) firmly on sill (5) next to wall. Make sure wall channel with vinyl is installed on the wall that will receive the glass panel and vinyl is to inside of shower.



Weep hole

- plumb and mark installation holes on wall.
- remove all parts.
- for ceramic tile installation, use a 3/16" masonry bit for drilling installation holes and install plastic wall anchors (21).
- for fiberglass walls, drill 9/84" holes.

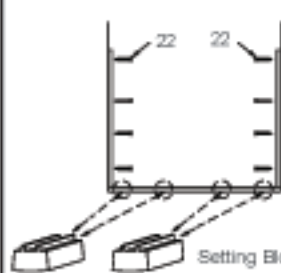

Step 3

- place a bead of sealant on each end of curb under threshold location.
- replace sill (5) in previous location.
- replace wall channels (6) and secure to wall with eight #6 x 1 1/2" pan head sheet metal screws (22).

Setting Block

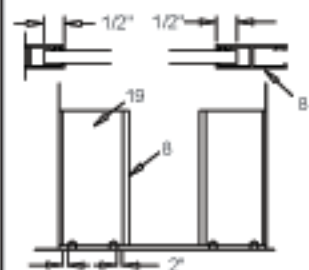

Step 4

- set the glass panel (19) into position. Setting blocks (7) should be positioned approximately 2" from each corner of glass.
- place the H mullion (8) into position with vinyl over glass and to the inside of shower. The glass will penetrate wall channels and H mullion approximately 1/2".
- repeat for other glass panel.

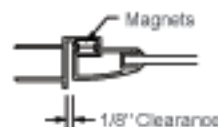

Step 5

- This door is reversible and can swing to the right or left. Decide which way you wish your door to swing. (A right-swing door is shown.)
- position strike jamb (12) over H mullion (8) with long side to inside of shower.
 - position hinge jamb (13) with door on opposite H mullion (8).
 - close door against strike jamb making sure door is flush against jamb and align door to opening.

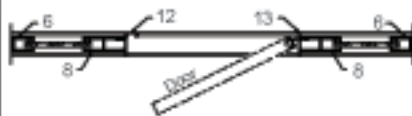

- close door against strike jamb making sure door is flush against jamb and align door to opening.
- Note:** if magnet does not pull door shut, reverse strike jamb magnet. Groove in magnet should match.

Step 6

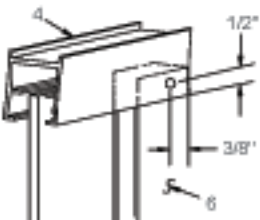

- place header (4) over wall channels (6) and H mullions (8).
- secure header to wall channels and H mullions by drilling 3/32" holes from inside of header into wall channels as shown.

IMPORTANT: note the location of glass before drilling, the drill bit must not hit the glass.

- secure H mullions to sill by drilling 3/32" holes from inside of sill into H mullions.
- secure with #6 x 1/2" pan head sheet metal screws (20).

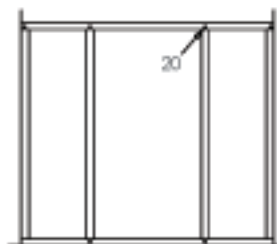

Step 7

- align unit to opening.
- from inside unit, secure strike jamb (12) to H mullion (8) and hinge jamb (13) and door to opposite H mullion (8) by drilling 3/32" holes approximately 3/8" from each end and in the center.
- secure with #6 x 1/2" pan head sheet metal screws (20).

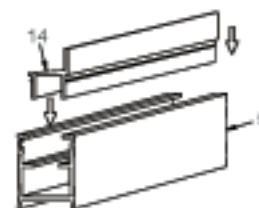
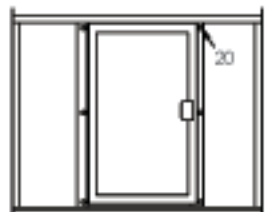

Step 8

- measure between hinge (13) and strike (12) jambs and cut both thresholds to size.
- with high side of threshold (14) to outside, snap threshold into header (4) and sill (5).

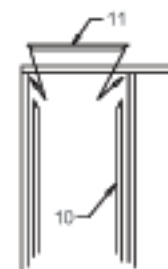

Step 9

- check panel glass alignment and install outside vertical wedge (10). **NOTE:** a lubricant such as WD-40 or hand lotion can be used to assist wedge vinyl installation. A block of wood is helpful for installing wedge vinyl.
- cut horizontal wedge vinyl (11) slightly longer than needed (approx. 1/8") and at a 45 degree angle.
- install inside end outside horizontal wedge vinyl into header and sill by starting vinyl at each end, then work from center to each end.
- repeat for other glass panel.

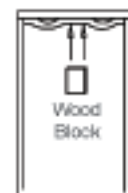

Wood Block

Step 10

- insert drip channel vinyl (24) into drip channel (17) and trim to size.
- insert plastic drip channel plug (18) into end of drip channel.
- with door closed, position drip channel on inside of door with a slope to the hinge side (13).
- mark the location, then clean door thoroughly with rubbing alcohol.
- peel protective cover off of double face tape and install drip channel to inside of door.
- drill three 3/32" holes from drip channel into door. **IMPORTANT:** holes must be drilled a minimum of 1/2" below exposed glass.
- secure with three #6 x 1/2" pan head sheet metal screws (20).

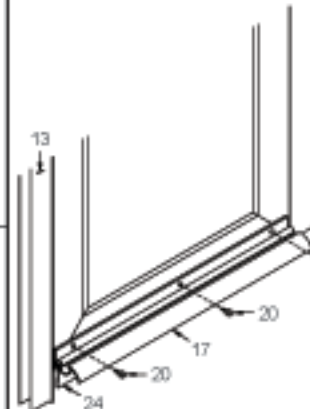

Step 11

- seal inside and outside of unit at any point unit meets wall and curb.